

CHiQ

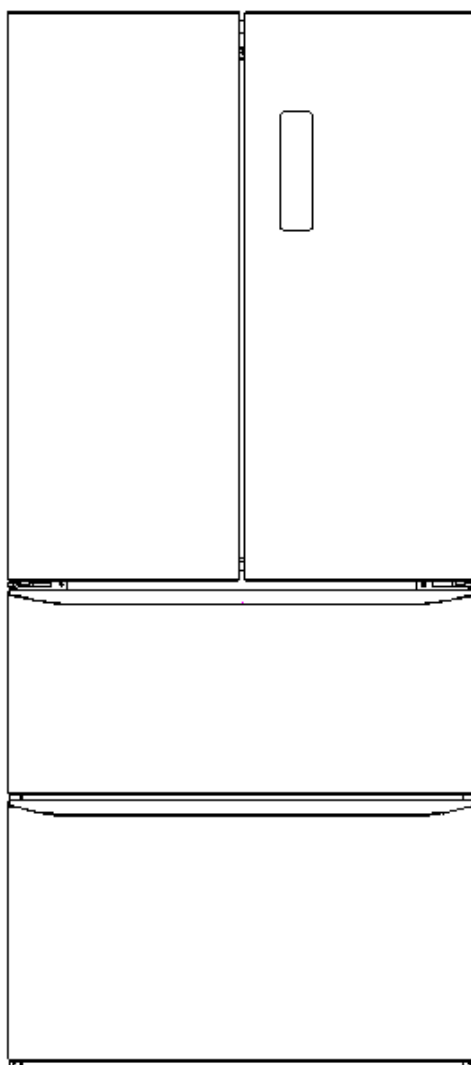

INSTRUCTION MANUAL

Model No.: CQRQ15Y4G2RS

I. SAFETY



WARNING!

It is hazardous for anyone other than authorized service personnel to carry out servicing or repairs which involves the removal of covers. To avoid the risk of an electric shock do not attempt to repair this appliance yourself.

WARNING!

Risk of fire / flammable materials.



Safety tips

Do not use electrical appliances such as a hair dryer or heater to defrost your Freezer.

Containers with flammable gases or liquids can leak at low temperatures.

Do not store any containers with flammable materials, such as spray cans, fire extinguisher refill cartridges etc. in the Freezer.

Do not place carbonated or fizzy drinks in the Freezer compartment. Ice lollies can cause “Frost/Freeze burns” if consumed straight from the Freezer.

Do not remove items from the Freezer compartment if your hands are damp/wet, as this could cause skin abrasions or “Frost/Freezer burns”. Bottles and cans must not be placed in the Freezer compartment as they can burst when the contents freeze.

Manufacturer’s recommended storage times should be adhered to. Refer to relevant instructions.

Do not allow children to tamper with the controls or play with the Freezer. The Freezer is heavy. Care should be taken when moving it. It is dangerous to alter the specification or attempt to modify this product in any way.

Do not store inflammable gases or liquids inside your Freezer.

If the power cable is damaged, it must be replaced by the manufacturer, its service agent or similarly qualified persons in order to avoid a hazard.

This appliance can be used by children aged from 8 years and above and persons with reduced physical, sensory or mental capabilities or lack of experience and knowledge if they have been given supervision or instruction concerning use of the appliance in a safe way and understand the hazards involved. Children shall not play with the appliance. Cleaning and user maintenance shall not be made by children without supervision.

This appliance is intended to be used in household and similar applications such as

- staff kitchen areas in shops, offices and other working environments;
- farm houses and by clients in hotels, motels and other residential type environments;
- bed and breakfast type environments;
- catering and similar non-retail applications.

Keep ventilation openings, in the appliance enclosure or in the built-in structure, clear of obstruction.

Do not use mechanical devices or other means to accelerate the defrosting process, other than those recommended by the manufacturer.

Do not damage the refrigerant circuit.

Do not use electrical appliances inside the food storage compartments of the appliance, unless they are of type recommended by the manufacturer.

Do not store explosive substances such as aerosol cans with a flammable propellant in this appliance.

This appliance is not intended for use by persons (including children) with reduced physical, sensory or mental capabilities, or lack of experience and knowledge, unless they have been given supervision or instruction concerning use of the appliance by a person responsible for their safety. Children should be supervised to ensure that they do not play with the appliance.

- WARNING: Keep ventilation openings, in the appliance enclosure or in the built-in structure, clear of obstruction.
- WARNING: Do not use mechanical devices or other means to accelerate the defrosting process, other than those recommended by the manufacturer.
- WARNING: Do not damage the refrigerant circuit.
- WARNING: Do not use electrical appliances inside the food storage compartments of the appliance, unless they are of the type recommended by the manufacturer.
- WARNING: Refrigerating appliances – in particular a refrigerator-freezer Type I – might not operate consistently (possibility of defrosting of contents or temperature becoming too warm in the frozen food compartment) when sited for an extended period of time below the cold end of the range of temperatures for which the refrigerating appliance is designed;
- WARNING: The necessity that, for doors or lids fitted with locks and keys, the keys be kept out of the reach of children and not in the vicinity of the refrigerating appliance, in order to prevent children from being locked inside.
- WARNING: The refrigerant used in your appliance and insulation materials requires special disposal procedures.
- WARNING: When positioning the appliance, ensure the supply cord is not trapped or damaged.
- WARNING: Do not locate multiple portable socket-outlets or portable power supplies at the rear of the appliance

Children aged from 3 to 8 years are allowed to load and unload refrigerating appliances.

- To avoid contamination of food, please respect the following instructions:
- Opening the door for long periods can cause a significant increase of the temperature in the compartments of the appliance.
 - Clean regularly surfaces that can come in contact with food and accessible drainage systems.
 - Clean water tanks if they have not been used for 48 h; flush the water system connected to a water supply if water has not been drawn for 5 days.
 - Store raw meat and fish in suitable containers in the refrigerator, so that it is not in contact with or drip onto other food.
 - Two-star frozen-food compartments are suitable for storing pre-frozen food, storing or making ice-cream and making ice cubes.
 - One-, two- and three-star compartments are not suitable for the freezing of fresh food.
 - If the refrigerating appliance is left empty for long periods, switch off, defrost, clean, dry, and leave the door open to prevent mould developing within the appliance.

Electrical Connection

⚡WARNING⚡

This appliance should be properly grounded for your safety. The power cord of this appliance is equipped with a three-prong plug which mates with the standard three prong wall outlets to minimize the possibility of electrical shock.

Do not, under any circumstances, cut or remove the third ground prong from the power cord supplied.

This refrigerator appliance requires a standard 220-240VAC 50/60Hz electrical outlet with three-prong ground.

This refrigerator appliance is not designed to be used with an inverter.

The cord should be secured behind the appliance and not left exposed or dangling to prevent accidental injury.

Never unplug the refrigerator by pulling the power cord. Always grip the plug firmly and pull straight out from the receptacle.

Do not use an extension cord with this appliance. If the power cord is too short, have a qualified electrician or service technician install an outlet near the appliance. Use of an extension cord can negatively affect the performance of the unit. Improper use of the grounded plug can result in the risk of electrical shock. If the power cord is damaged, have it replaced by an authorized service center.

Climate Range

The information about the climate range of the appliance is provided on the rating plate. It indicates at which ambient temperature (that is, room temperature, in which the appliance is working) the operation of the appliance is optimal (proper).

Climate range	Permissible ambient temperature
SN	from +10°C to +32°C
N	from +16°C to +32°C
ST	from +16°C to +38°C
T	from +16°C to +43°C

Note: Given the limit values of the ambient temperature range for the climate classes for which the refrigerating appliance is designed and the fact that the internal temperatures could be affected by such factors as location of the refrigerating appliance, ambient temperature and the frequency of door opening, the setting of any temperature control device might have to be varied to allow for these factors, if appropriate.

If the power cable is damaged, it must be replaced by the manufacturer, its service agent or similarly qualified persons in order to avoid a hazard.

Locks

If your Refrigerator is fitted with a lock, keep the key out of reach and not in the vicinity of the appliance to prevent children being entrapped. When disposing of an old Refrigerator, break off any old locks or latches as a safeguard.

Freon-free

The freon-free refrigerant (R600a) and the foaming insulation material (cyclopentane) that is environmentally friendly are used for the refrigerator, causing no damage to the ozone layer and having a very small impact on the global warming. R600a is flammable, and sealed in a refrigeration system, without leakage during normal use. But, in case of refrigerant leakage due to the refrigerant circuit being damaged, be sure to keep the appliance away from open flames and open the windows for ventilation as quickly as possible.

II. Product Features

This is an inverter fridge-freezer adopting the multiple-door design. Its upper part is the fridge compartment for fresh food storage, such as fruits, vegetables, eggs, milk, cooked foods, etc.; and its lower part is the freezer compartment where fish, meat, etc. can be frozen for the long-term storage.

★Computer control

Adopting the electronic temperature control mode, the fridge-freezer is designed with a LED display screen, by which the temperature of each compartment and the working parameters can be managed and set.

★Inverter technology

Integrated with precise frequency conversion, noise reduction, energy saving, precise temperature control and other technologies, the fridge-freezer boasts of superior performances. Furthermore, working efficiency of the inverter compressor can be automatically adjusted according to the ambient temperature and the set temperature, so as to keep the fridge-freezer operating in its optimal state.

★LECO

The fridge-freezer is internally configured with the LECO device for the net flavor and fresh-keeping purpose, with the preservation time of fruits and vegetables effectively extended.

★Green technology

The freon-free refrigerant and foaming insulation material are used for the fridge-freezer, causing no damage to the ozone layer and having a very small impact on the global warming, so it is the environmentally friendly product.

★Stylish appearance

Adopting the optimized man-machine engineering design, this French door refrigerator is easy to be opened and looks luxurious and elegant.

★Foldable shelf (optional) The innovatively foldable shelf can be unfolded for the separate use, or folded for the combined use, thus satisfying the diversified storage demands.

★More user-friendly designs

Such functions as wide working voltage range, automatic temperature control, power-off memory, power-on delay, automatic alarm, fast freezing, and fridge power-off, etc. are available.

Explosive views and parts list

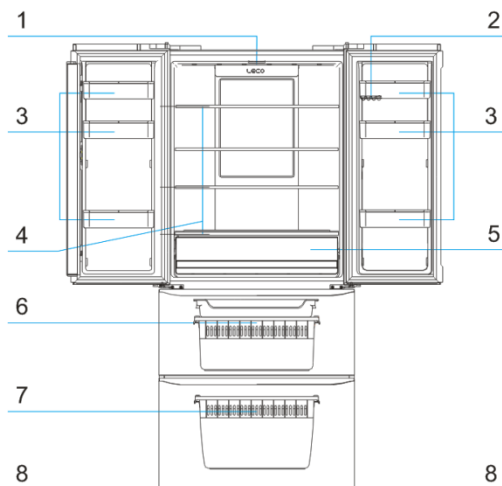

No	Description
1	Light
2	Egg Tray
3	Bottle Rack
4	Refrigerator Glass Shelf
5	Salad Crisper
6	Upper Freezer Drawer
7	Bottom Freezer Drawer
8	Adjustable Foot

Due to technological innovation, the descriptions of the product in this manual may not be completely consistent with your refrigerator. Details are in accordance with the material item.

III. Preparations for use

Installation location

1. Ventilation condition

The position you select for the refrigerator installation should be well-ventilated and has less hot air. Do not locate the refrigerator near a heat source such as cooker, boiler, and avoid it from direct sunlight, thus guaranteeing the refrigeration effect while saving energy consumption. Do not locate the refrigerator in the damp place, so as to prevent the refrigerator from rusting and leaking electricity. The result of the total space of the room in which the refrigerator is installed being divided by the refrigerant charge amount of the refrigerator shall not be less than 8 g/ M³.

Note: The amount of refrigerant charged for the refrigerator can be found on the nameplate.

2. Heat dissipation space

When working, the refrigerator gives off heat to surroundings. Therefore, at least 300mm of free space should be spared at the top side, more than 100mm on both sides, and above 50mm at the back side of the refrigerator.

Dimensions in mm:

W	D	H	A	B	C(°)	E	F
785	717	1815	1274	1063	125	50	100

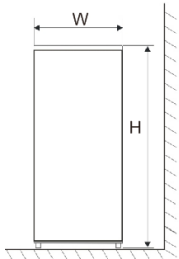

Fig. 1

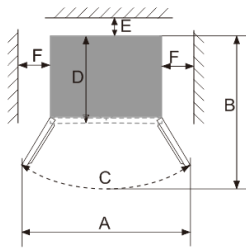

Fig. 2

Note: Figure 1, Figure 2 only illustrate the space demand of the product.

3. Level ground

Place the refrigerator on the solid and flat ground (floor) to keep it stable, or else, it will give rise to vibration and noise. When the refrigerator is placed on such flooring materials as carpet, straw mat, polyvinyl chloride, the solid backing plates should be applied underneath the refrigerator, so as to prevent color change due to heat dissipation.



Unobstructed ventilation shall be maintained around the appliance or in an embedded structure.

Preparations for use

1. Standing time

After the refrigerator is properly installed and well cleaned, do not switch it on immediately. Make sure to energize the refrigerator after more than 1 hour of standing, so as to ensure its normal operation.

2. Cleaning

Confirm the accessory parts inside the refrigerator and wipe the inside with a soft cloth.

3. Power-on

Insert the plug into the solid socket to start the compressor. After 1 hour, open the freezer door, if the temperature inside the freezer compartment drops obviously, it indicates the refrigeration system is working normally.

4. Storage of food

After the refrigerator runs for a period of time, the internal temperature of the refrigerator will be automatically controlled according to the user's temperature setting. After the refrigerator is fully cooled, put in foods, which usually need 2~3 hours to be fully cooled. In summer, when the temperature is high, it takes more than 4 hours for the foods to be fully cooled (Try to open the refrigerator door as less as possible before the internal temperature cools down).



If the refrigerator is installed in the moisture place, make sure to check whether the ground wire and leakage circuit breaker are normal. If vibration noises are produced due to the refrigerator contacting the wall or if the wall gets blackened by air convection around the compressor, move the refrigerator away from the wall. Setting up the refrigerator may cause jamming noise or image chaos to the mobile phone, fixed-line telephone, radio receiver, television set surrounding it, so try to keep the refrigerator as far away as possible in such case.

IV. Functions

The display panel is designed on the fridge door, illustrated as the right figure.

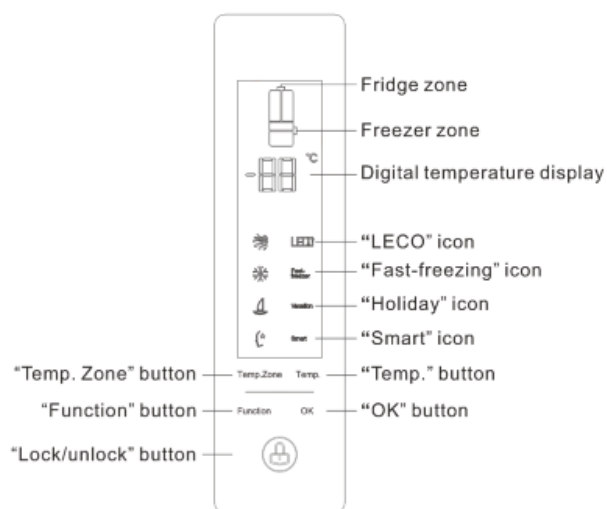

Function Settings

When the refrigerator system is connected to power supply for the first time, all icons on the display panel gets illuminated for 2s, and the system runs in the Smart mode by default. When all the doors are close, the display gets extinguished automatically if no key operation within 3 minutes. When the display is off, it will light up if any door is opened or any key is pressed.

The following key operations are valid only when the keys are unlocked and gets illuminated on the display. (refer to 1.6 for unlocking the keys)

1.Functions

1.1Temp. setting

1) Fridge temperature setting

Press the Temp. Zone key to select the fridge zone, with the corresponding icon flickering, and then press the Temp. key to adjust the temperature, finally press the OK or wait for 5s to validate the above temperature setting.

The fridge temperature setting cycles as following:

5→6→7→8→OF→2→3→4→5;

OF refers to Fridge Off, and when OF takes effect, the fridge will stop cooling.

⚠ Take foods out of the fridge compartment before setting this function.

2) Freezer temperature setting

Press the Temp. Zone key to select the freezer zone, with the corresponding icon flickering, and then press the Temp. key to adjust the temperature, finally press the OK or wait for 5s to validate the above temperature setting.

The freezer temperature setting cycles as following:

-18→-17→-16→-24→-23→-22→-21→-20→-19→-18;

1.2 LECO

1) When the refrigerator is powered on, the LECO net flavor function will run automatically on a regular basis, lasting for 20 minutes each time; the LECO system decomposes odors and microorganisms into CO₂ and H₂O. At the same time, the LECO system releases free radicals to actively eliminate bacteria, creating a cleaner cooling space.

2) Enabling the LECO function manually

◆ Press the Function key to select LECO until the icon of LECO gets flickering, and then press the OK key for confirmation. If the OK key is not pressed within 5s, the current setting will be invalidated.

3) Exiting the LECO function

◆ The LECO function gets exited automatically 20 minutes after it is enabled.

◆ Disabling the LECO function manually: Press the Function key to select LECO until the corresponding icon gets flickering, and then press the OK key to validate the setting.

1.3 Fast Freezing

1) When the Fast Freezing function is enabled, the freezer temperature will be controlled at -32°C automatically, and after 26 hours of running, the Fast Freezing function gets exited. Cooling down the freezer temperature in a rapid manner is beneficial to the prevention of food nutrition against lost and the preservation of freshness.

⚠ Under the Fast-Freezing mode, the freezer temperature is subjected to no adjustment.

2) Enabling the Fast-Freezing function

◆ Press the Function key to select Fast Freeze until the corresponding icon gets flickering, and then press the OK key within 5s for confirmation. If the OK key is not pressed within 5s, the setting will be invalidated.

3) Exiting the Fast-Freezing function

◆ After a cumulative running period of 26 hours, the Fast Freeze function will exit automatically.

◆ Under the Fast Freeze mode, press the Function key to select Fast Freeze until the corresponding icon gets flickering, and then press the OK key for confirmation, the Fast Freeze function will get exited.

◆ When the Smart function is enabled, the Fast-Freezing function will be disabled automatically.

1.4 Holiday

1) When the Holiday function is enabled, the fridge temperature will be controlled at 14°C. When you are out for a quite

long time, you can set the Holiday function to keep the refrigerator running with low energy consumption, while ensuring the fresh food compartment is free from undesirable smell and the freezer compartment operates normally.

! Be sure to take out all foods from the fresh food compartment before setting this function.

! Under the Holiday mode, the fridge temperature is subject to no change.

2) Enabling the Holiday function

◆ Press the Function key to select Holiday until the corresponding icon gets flickering, and then press the OK key within 5s for confirmation. If the OK is not pressed within 5s, the setting will be invalidated.

3) Exiting the Holiday function

◆ Under the Holiday mode, press the Function key to select Holiday until the corresponding gets flickering, and then press the OK key for confirmation. The Holiday function will get exited.

◆ When the Smart function is enabled, the Holiday function will be disabled automatically.

1.5 Smart

1) When the Smart function is enabled, the temperature of the fresh food compartment is controlled at 4°C, and that of the freezer compartment at -18°C, so that foods can be stored in the best condition while the refrigerator is running more efficiently and with better performance.

! Under the Smart mode, the fresh food compartment temperature and the freezer compartment temperature are subject to no change.

2) Enabling the Smart function

◆ Press the Function key to select Smart until the corresponding icon gets flickering, and then press the OK key within 5s for confirmation. If the OK is not pressed within 5s, the setting will be invalidated.

3) Exiting the Smart function

◆ Under the Smart mode, press the Function key to select Smart until the corresponding gets flickering, and then press the OK key for confirmation. The Smart function will get exited.

◆ When the Holiday or Fast Freeze function is enabled, the Smart function will be disabled automatically.

1.6 Child Lock

1) When the Child Lock function is enabled, the temperature and function are subjected to no change to prevent maloperation.

2) In case of no key operation within 3 minutes, the Child Lock function will be enabled automatically.

3) Enabling/exiting the Child Lock function manually

◆ Press and hold down the Lock/Unlock for 3s, then the Child Lock function can be enabled/disabled.

1.7 Door open alarm

If any door is open for more than 3 minutes, buzzer alarms will be continuously issued, which can be stopped when any key is pressed, but will be restored after 3 minutes if the door keeps open. The alarms will not be lifted until the door is closed.

1.8 Power cut memory

In case of power failure, the refrigerator will maintain the operating state before power failure when power supply is restored.

1.9 Power-on delay

In order to protect the refrigerator compressor from being damaged in the case of short-time power failure (i.e., less than 5 minutes), the compressor will not be started immediately after it is powered on.

1.10 Over-temperature alarm (only after power outage)

When the refrigerator system is powered on, if the freezer sensor temperature is higher than -10°C, digits of the freezer zone get flickering on the display. The freezer temperature can be displayed when any key is pressed, and the normal display will be restored when any key is pressed again or after 10s.

1.11 Fault alarm

In case E0, E1, E2, EH, EC or EF is displayed on the operation panel, it indicates fault with the refrigerator. Please contact the aftersales person for visiting service in such case.

Instructions for use of the foldable glass shelf (if applicable)

Pull out the lower glass shelf first.



1. Move the lower shelf in the manner as illustrated below.

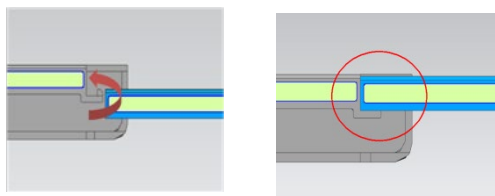

2. Make sure the shelf should be put in position as illustrated below, so that it will not come off.

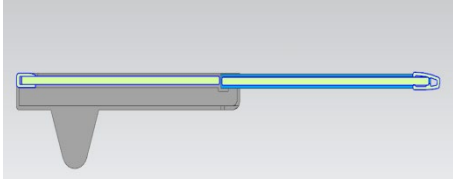

V. Instructions for food storage

Precautions for use

- The appliance might not operate consistently (there is possibility of defrosting or temperature becoming too warm in the frozen food compartment) when sited for an extended period of time below the cold limit of the temperature range for which the refrigerating appliance is designed
- The information of climate type of the appliance is provided on the rating plate.
- The internal temperature could be affected by such factors as the location of refrigerating appliance, ambient temperature, and frequency of door open, etc., and if appropriate, a warning that setting of any temperature control device might have to be varied to allow for these factors should be made.
- Effervescent drinks should not be stored in the freezer compartment or the low-temperature compartment, and some products such as water ices should not be consumed too cold.

Food storage location

Due to the cold air circulation in the refrigerator, the temperature of each area in the refrigerator is different, so different kinds of food should be placed in different areas.

The fresh food compartment is suitable for the storage of such foods as need not to be frozen, the cooked food, beer, eggs, some condiments that need cold preservation, milk, fruit juice, etc. The crisper box is suitable for the preservation of vegetables, fruits, etc.

The freezer compartment is suitable for the storage of ice cream, frozen food and the foods to be preserved for a long time.

Use of the fresh food compartment

Set the temperature of the fresh food storage compartment between 2 °C ~ 8 °C, and store the foods that are intended for short-term storage, or to be eaten at any time in the fresh food compartment.

Fridge shelf: When removing the shelf, lift it up first, and then pull it out; and when installing the shelf, place it into position before putting it down. (For the two-section shelf, push the first section to the rear end, and then pull the second section out). Keep the shelf rear flange upward, to prevent foods from contact the liner wall. When taking out or putting in the shelf, hold it firmly, and handle with care to avoid damage.

Crisper box: Pull out the crisper box for access to food. After using or cleaning the cover plate of the crisper box, be sure to put it back onto the crisper, so that the internal temperature of the crisper box will not be affected.

Cautions for food storage

You'd better clean the foods and wipe them dry before storing them inside the refrigerator. Before foods are put in the refrigerator, it is advisable to seal them up, so as to prevent water evaporation to keep fresh fruits and vegetables on one hand, and prevent taint of odor on the other hand.

Do not put too many or too weight foods inside the refrigerator. Keep enough space between foods; if too close, the cold air flow will be blocked, thus affecting the refrigeration effect. Do not store excessive or overweight foods, to avoid the shelf from being crushed. When storing the foods, keep a distance away from the inner wall; and do not place the water-rich foods too close to the fridge rear wall, lest they get frozen on the inner wall.

Categorized storage of foods: Foods should be stored by category, with the foods you eat every day placed in front of the shelf, so that the door open duration can be shortened and food spoilage due to expiration can be avoid.

Energy-saving tips: Allow the hot food cool down to the room temperature before putting it in the refrigerator. Put the frozen food in the fresh food compartment to thaw, using the low temperature of the frozen food to cool the fresh food, thus saving energy.

Storage of fruits and vegetables

In the case of refrigerating appliances with chill compartment, a statement to the effect that some types of fresh vegetables and fruits are sensitive to cold and therefore are not suitable for storage in this kind of compartment should be made.

Use of the frozen food storage compartment

The freezer temperature is controlled below -18 °C, and it is advisable to store the food for long-term preservation in the freezer compartment, but the storage duration indicated on the food packaging should be adhered to.

The freezer drawers are used to store food that needs to be frozen. Fish and meat of large block size should be cut into small pieces and packed into fresh-keeping bags before they are evenly distributed inside the freezer drawers.

Fast freezing

- (1) Refer to the description about fast freezing function in the "Function" section.
- (2) Compared with the normal freezing, fast freezing enables food to pass through the maximum ice crystal formation zone at the fastest speed. Fast freezing can freeze the food water content into fine ice crystals, without damaging the cell membrane, so cell juice will not be lost when thawing, and the original freshness and nutrition of food can be maintained.
- (3) The fast-freezing function is designed to preserve nutrition of the frozen food, with the food thoroughly frozen in the shortest time. Fast freezing consumes more energy than the normal freezing does.

★ Allow the hot foods to cool down to the room temperature before putting them in the freezer compartment.

★ Do not put a glass container with liquid or the canned liquid that is sealed in the freezer compartment, so as to avoid

burst due to volume expansion after the liquid gets frozen up.

★Divide the food into appropriately small portions

★You'd better pack the food up before freezing it, and the packing bag used should be dry, in case the packing bags are frozen together. Foods should be packed or covered by such suitable materials as are firm, tasteless, impervious to air and water, non-toxic and pollution-free, to avoid cross-contamination and transfer of odor.

Tips for shopping the frozen foods

1. When you are buying frozen food, look at the Storage Guidelines on the packaging. You will be able to store each item of frozen food for the period shown against the star rating. This is usually the period stated as "Best to use them before*", found on the front of the packaging.

2. Check the temperature of the frozen food cabinet in the shop where you buy the frozen foods.

3. Make sure the frozen food package is in perfect condition.

4. Always buy frozen products last on your shopping trip or visit to the supermarket.

5. Try to keep frozen food together whilst shopping and on the journey home, as this will help to keep the food cooler.

6. Don't buy frozen food unless you can freeze it straight away. Special insulated bags can be bought from most supermarkets and hardware shops. These keep the frozen foods cold longer.

7. For some foods, thawing before cooking is unnecessary. Vegetables and pasta can be added directly to boiling water or steam cooked. Frozen sauces and soups can be put into a saucepan and heated gently until thawed.

8. Use quality food and handle it as little as possible. When foods are frozen in small quantities, it will take less than for them to freeze up and thaw.

9. Estimate the amount of foods to be frozen up. When freezing large amounts of fresh food, adjust the temperature control knob to the low mode, with the freezer temperature lowered. So, foods can be frozen up in fast manner, with the food freshness well kept.

VI. Tips for special needs

Moving the refrigerator/freezer

•Location

Do not place your refrigerator/freezer near a heat source, e.g. cooker, boiler or radiator. Avoid it from direct sunlight in out-buildings or sun lounges.

•Leveling

Make sure to level your refrigerator/freezer using the front leveling feet. If not level, the refrigerator/freezer door gasket sealing performance will be affected, or even it may lead to the operating failure of your refrigerator/freezer.

After locating the refrigerator/freezer in position, wait for 4 hours before using it, so as to allow the refrigerant to settle.

•Installation

Do not cover or block the vents or grilles of your appliance.

When you are out for a long time

• If the appliance will not be used for several months, turn it off first, and then unplug the plug from the wall outlet.

• Take out all foods.

• Clean and dry the interior thoroughly. To prevent odor and mold growth, leave the door ajar: block it open or have the door removed if necessary.

• Keep the cleaned appliance in a dry, ventilated place and away from the heat source, place the appliance smoothly, and do not place heavy objects on top of it.

• The unit should not be accessible to child's play.

VII. Maintenance and cleaning

 **Before cleaning, unplug the power plug first; Do not plug in or plug out the plug with wet hand, because there is a risk of electric shock and injury. Do not spill water directly on the refrigerator, to avoid rust, electricity leakage and accidents. Do not stretch your hands into the bottom of the refrigerator, since you might be scratched by sharp metal corners.**

Internal cleaning and external cleaning

The food residuals in the refrigerator are liable to produce bad odor, so the refrigerator must be cleaned regularly. The fresh food compartment is usually cleaned once a month.

Remove all shelves, crisper box, bottle racks, cover board, and drawers etc., and clean them with a soft towel or sponge dipped in warm water or neutral detergent.

Clear off the dusts accumulated on the rear panel and side plates of the refrigerator often.

After using detergent, be sure to rinse it with clean water, and then wipe it dry.

 **Do not use bristle brush, steel wire brush, detergent, soap powder, alkaline detergent, benzene, gasoline, acid, hot water and other corrosive or soluble items to cleanse the cabinet surface, door gasket, plastic decorative parts, etc., so as to avoid damage.**

Carefully wipe dry the door gasket, clean the groove using a wooden chopstick wrapped with cotton string. After the cleaning, fix the four corners of the door gasket first, and then embed it segment by segment into the door groove.

Interruption of power supply or failure of the refrigerating system

• Take care of the frozen foods in the event of an extended non-running of the refrigerating appliance (such as interruption of power supply or failure of the refrigerating system).

• Try to open the refrigerator door as less as possible, in this way can food safely and freshly kept for hours even in hot

summer.

•If you get the power outage notice in advance:

- 1) Adjust the thermostat knob to the high mode an hour in advance, so that foods get fully frozen (Do not store new food during this time!). Restore the temperature mode to the original setting when power supply becomes normal in a timely manner.
- 2) You can also make ice with a watertight container, and put it in the upper part of the freezer, so as to extend the time for fresh food to be stored.

! Note: Once the refrigerator is used, you'd better use it continuously; and under normal circumstance, do not stop its use, so as not to affect the service life.

Defrosting

This appliance is designed with automatic defrosting function, thus no need to defrost it manually.

Changing the lamp

The LED lamp is used by the refrigerator for lighting, which features low energy consumption and long service life. In case of any abnormality, please contact the after-sales personnel for visiting service. The lamps can only be replaced by the manufacturer, together with a part of the appliance.

Safety-check after maintenance

- Is the power cord broken or damaged?
- Is the power plug firmly inserted into the socket?
- Is the power plug abnormally overheat?

! Note: Electric shock and fire accident may be caused in case the power cord and plugs damaged or stained by dust. If any abnormality, please unplug the power plug and get in contact with the vendor.

◆ How to disassemble the parts.

Fridge door bottle rack:

Hold the bottle rack with both hands, and then push it up.

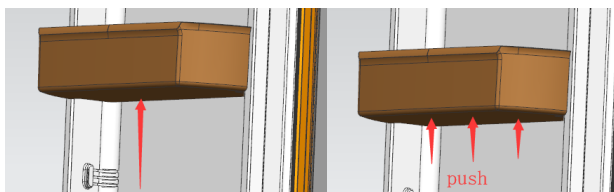

Fridge shelf:

Hold one end of the shelf, and lift it up while pulling it outwards.

VIII. Simple fault analysis and elimination

With regard to the following small faults, not every failure needs to be fixed by the technical service personnel; you can try to solve the problem.

Case	Inspection	Solutions
Completely non-refrigeration	<ul style="list-style-type: none"> •Is power plug off? •Are breakers and fuses broken? •No electricity or line trip? 	<ul style="list-style-type: none"> •Re-plug •Opening the door and checking whether the lamp is lit.
Abnormal noise	<ul style="list-style-type: none"> •Is refrigerator stable? •Does refrigerator contact the wall? 	<ul style="list-style-type: none"> •Adjusting refrigerator's leveling feet. •Off the wall.
Poor refrigerating efficiency	<ul style="list-style-type: none"> •Do you put hot food or too much food? •Do you open the door frequently? •Do you clip food bag to the door gasket? •Direct sunlight or near a furnace or stove? •Is it well-ventilated? •Temperature setting in too high? 	<ul style="list-style-type: none"> •Putting food into refrigerator when hot food becomes cool. •Checking and closing the door. •Removing the refrigerator from the heat source. •Emptying the distance to maintain good ventilation.. •Setting to the appropriate temperature.
Peculiar smell in refrigerator	<ul style="list-style-type: none"> •Any spoiled food? •Do you need to clean refrigerator? •Have you packed food of strong flavors? 	<ul style="list-style-type: none"> •Throwing away spoiled food. •Cleaning refrigerator. •Packing food of strong flavors.
•No key response	<ul style="list-style-type: none"> • Check whether the Child Lock function is enabled on the display panel. 	<ul style="list-style-type: none"> •Press & hold the "OK" key for 3 seconds to unlock the key, and then conduct the key operation. (For details, refer to the Child Key function.)
•Temperature setting impossible	<ul style="list-style-type: none"> • Check whether the Smart, Fast Freeze or Holiday function is enabled 	<ul style="list-style-type: none"> •Exit the special function mode, and then set up the temperature (for details refer to the Functions section)

	on the display panel.	
<ul style="list-style-type: none"> Freezer temperature displayed on the panel, with the temperature digits flashing 	<ul style="list-style-type: none"> Is power cut before? 	<ul style="list-style-type: none"> Press any key to lift the alarm (refer to the Overtemperature alarm function), and then check the foods inside the fridge and freezer compartments get spoiled.
<ul style="list-style-type: none"> The left fridge door unable to be closed tightly. 	<ul style="list-style-type: none"> Check whether the flip beam is restored to its original position. 	<ul style="list-style-type: none"> Turn the door flip beam by hand to restore it to the correct position, and then close the door. 

() Note: If the above descriptions are inapplicable to troubleshooting, do not disassemble and repair it yourself. Repairs carried out by inexperienced persons may cause injury or serious malfunctioning. Contact the local store where your purchase was made. This product should be serviced by an authorized engineer and only genuine spare parts should be used.

When the appliance is not in use for long periods, disconnect from the electricity supply, empty all foods and clean the appliance, leaving the door ajar to prevent unpleasant smells.

IX. Certifications

Electrical information

This electrical appliance must be grounded

This product is equipped with a plug, which is suitable for all houses equipped with sockets meeting the current specifications

If the fitted plug is not suitable for your socket outlets, it should be cut off and carefully disposed of. To avoid a possible shock hazard, do not insert the discarded plug into a socket.

This product complies the EEC directives.

X. Safe recovery instructions

Disposal

Old appliances still have some surplus value. An environmentally friendly approach will ensure that valuable raw materials are recycled.

The refrigerants used in your equipment and insulation materials require special handling procedures. Make sure there is no pipe damage on the back of the equipment before handling.

Up-to-date information on the options for disposing of old equipment and packaging from old equipment can be obtained from the local municipal office.

Correct disposal of this product	
	<p>This marking indicates that this product should not be disposed with other household wastes throughout the EU. To prevent possible harm to the environment or human health from uncontrolled waste disposal, recycle it responsibly to promote the sustainable reuse of material resources. To return your used device, please use the return and collection systems or contact the retailer where the product was purchased. They can take this product for environmentally safe recycling.</p>