

CHiQ

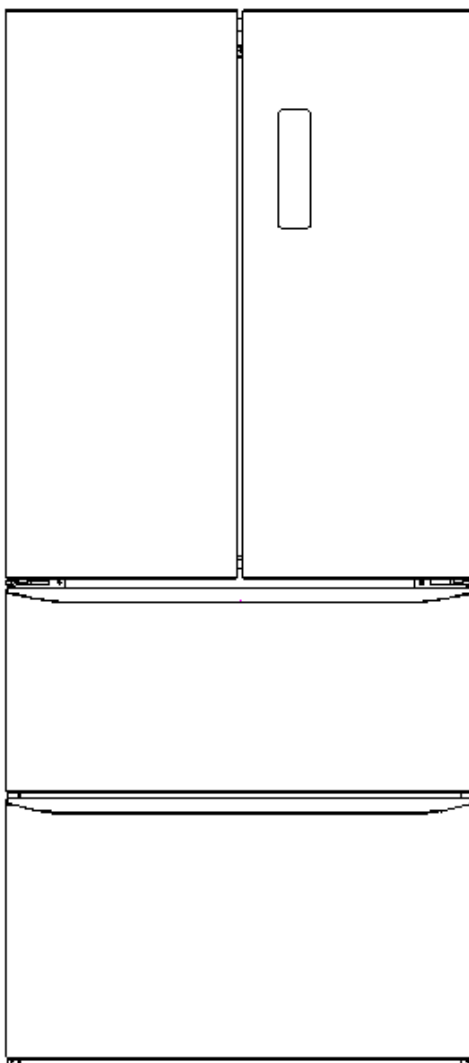

INSTRUCTION MANUAL

Model No.: CQRQ15Y1GD1RS

I. IMPORTANT SAFETY INSTRUCTIONS

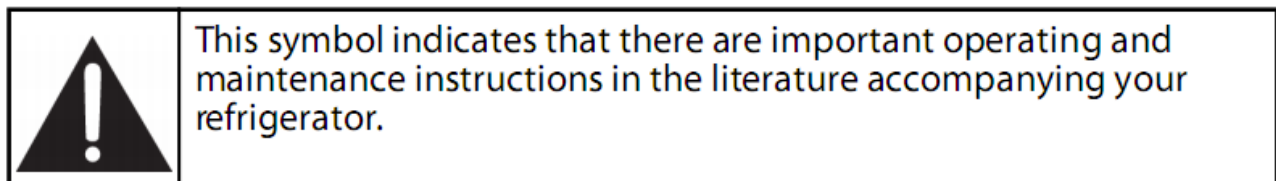
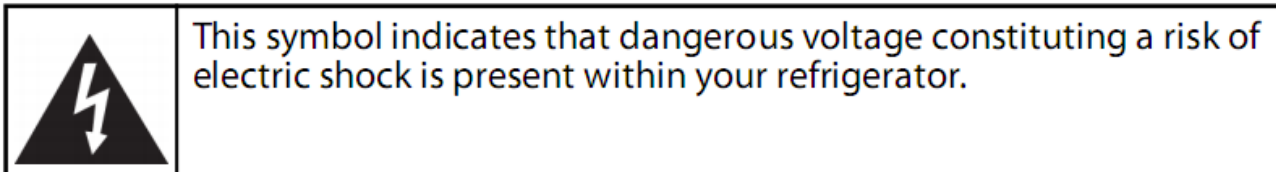
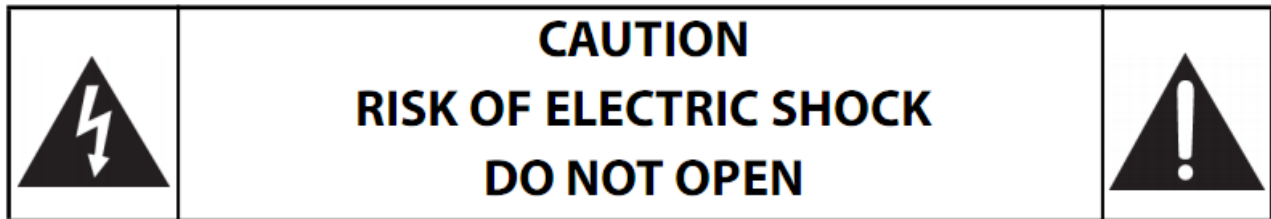

WARNINGS

1. Read these instructions.
2. Keep these instructions.
3. Heed all warnings.
4. Follow all instructions.
5. Do not use your refrigerator near water.
6. Clean only with a damp cloth.
7. Do not block any ventilation openings. Install in accordance with the manufacturer's instructions.
8. Do not install near any heat sources, such as radiators, heat registers, stoves, or other apparatus (including amplifiers) that produce heat.
9. Do not defeat the safety purpose of the polarized or grounding-type plug. A polarized plug has two blades with one wider than the other. A grounding type plug has two blades and a third grounding prong. The wide blade or the third prong is provided for your safety. If the provided plug does not fit into your outlet, consult an electrician for replacement of the obsolete outlet.
10. Protect the power cord from being walked on or pinched, particularly at plugs, convenience receptacles, and the point where it exits from your refrigerator.
11. Do not attempt to modify or extend the power cord of your refrigerator.
12. Unplug your refrigerator during lightning storms or when it will not be used for long periods of time.
13. Make sure that the available AC power matches the voltage requirements of your refrigerator.
14. Do not handle the plug with wet hands. This could result in an electric shock.
15. Unplug the power cord by holding the plug, never by pulling the cord.
16. Turn off your refrigerator before unplugging it.
17. Refer all servicing to qualified service personnel. Servicing is required when your refrigerator has been damaged in any way, for example, the power-supply cord or plug is damaged, liquid has been spilled or objects have fallen into your refrigerator, your refrigerator has been exposed to rain or moisture, is not operating normally, or has been dropped.
18. To reduce the risk of fire or electric shock, do not expose your refrigerator to rain, moisture, dripping, or splashing, and the objects filled with liquids should not be placed on top of it.
19. Do not use extension cords or ungrounded (two prong) adapters. If the power cord is too short, have a qualified electrician install an outlet near your refrigerator. Use of an extension cord can negatively affect your refrigerator's performance.
20. Your refrigerator is not intended for use by persons (including children) with reduced physical, sensory, or mental capabilities, or lack of experience and knowledge, unless they have been given supervision or instruction concerning use of your refrigerator by a person responsible for their safety.
21. Children should be supervised to ensure that they do not play with your refrigerator.
22. If the power cord is damaged, it must be replaced by the manufacturer, its service agent, or similarly qualified person, in order to avoid a hazard.



Electric Shock Hazard

Failure to follow these instructions can result in electric shock, fire, or death.

1. **WARNING**—Keep ventilation openings, in both your refrigerator and the built-in structure, clear of obstruction.
2. **WARNING**—Do not touch the interior of your refrigerator with wet hands. This could result in frostbite.
3. **WARNING**—Do not use mechanical devices or other means to accelerate the defrosting process, other than those recommended by the manufacturer.
4. **WARNING**—Do not damage the refrigerant circuit.
5. **WARNING**—Do not damage the refrigerant tubing when handling, moving, or using your refrigerator.
6. **WARNING**—**DANGER**—Never allow children to play with, operate, or crawl inside your refrigerator.
Risk of child entrapment; Before you throw away your old refrigerator,
 - Take off the door.
 - Leave the shelves in place so that children may not easily climb inside.
7. **WARNING**—Do not use electrical appliances inside the food storage compartments of the appliance unless they are of the type recommended by the manufacturer.
8. Unplug your refrigerator before carrying out user maintenance on it.
9. If a component part is damaged, it must be replaced by the manufacturer, its service agent, or similar qualified persons in order to avoid a hazard.
10. Follow local regulations regarding disposal of your refrigerator due to flammable refrigerant and gas. All refrigeration products contain refrigerants, which must be removed before disposal. It is the consumer's responsibility to comply with the local regulations when disposing of this product.
11. Do not store explosive substances such as aerosol cans with a flammable propellant in this appliance.
12. This appliance is intended to be used in household and similar applications such as
 - staff kitchen areas in shops, offices and other working environments.
 - farm houses and by clients in hotels, motels and other residential type environments.
 - bed and breakfast type environments.
 - catering and similar non-retail applications.

Grounding requirement

Your refrigerator must be grounded. Your refrigerator is equipped with a cord having a grounding wire with a grounding plug. The plug must be inserted into an outlet that is correctly installed and grounded. Incorrect use of the grounding plug can result in a risk of electric shock. Consult a qualified electrician or service person if the grounding instructions are not completely understood, or if doubt exists as to whether your refrigerator is correctly grounded.

Electrical Connection

⚡WARNING⚡

This appliance should be properly grounded for your safety. The power cord of this appliance is equipped with a three-prong plug which mates with the standard three prong wall outlets to minimize the possibility of electrical shock. Do not, under any circumstances, cut or remove the third ground prong from the power cord supplied. This refrigerator appliance requires a standard 115VAC /60Hz electrical outlet with three-prong ground. This refrigerator appliance is not designed to be used with an inverter. The cord should be secured behind the appliance and not left exposed or dangling to prevent accidental injury. Never unplug the refrigerator by pulling the power cord. Always grip the plug firmly and pull straight out from the receptacle. Do not use an extension cord with this appliance. If the power cord is too short, have a qualified electrician or service technician install an outlet near the appliance. Use of an extension cord can negatively affect the performance of the unit. Improper use of the grounded plug can result in the risk of electrical shock. If the power cord is damaged, have it replaced by an authorized service center.

Locks

If your Refrigerator is fitted with a lock, keep the key out of reach and not in the vicinity of the appliance to prevent children being entrapped. When disposing of an old Refrigerator, break off any old locks or latches as a safeguard.

Freon-free

The freon-free refrigerant (R600a) and the foaming insulation material (cyclopentane) that is environmentally friendly are used for the refrigerator, causing no damage to the ozone layer and having very small impact on the global warming. R600a is flammable, and sealed in a refrigeration system, without leakage during normal use. But, in case of refrigerant leakage due to the refrigerant circuit being damaged, be sure to keep the appliance away from open flames and open the windows for ventilation as quickly as possible.

II. Product Features

This is an inverter fridge-freezer adopting the multiple-door design. Its upper part is the fridge compartment for fresh food

storage, such as fruits, vegetables, eggs, milk, cooked foods, etc.; and its lower part is the freezer compartment where fish, meat, etc. can be frozen for the long-term storage.

★Computer control

Adopting the electronic temperature control mode, the fridge-freezer is designed with a LED display screen, by which the temperature of each compartment and the working parameters can be managed and set.

★Inverter technology

Integrated with precise frequency conversion, noise reduction, energy saving, precise temperature control and other technologies, the fridge-freezer boasts of superior performances. Furthermore, working efficiency of the inverter compressor can be automatically adjusted according to the ambient temperature and the set temperature, so as to keep the fridge-freezer operating in its optimal state.

★LECO

The fridge-freezer is internally configured with the LECO device for the net flavor and fresh-keeping purpose, with the preservation time of fruits and vegetables effectively extended.

★Green technology

The freon-free refrigerant and foaming insulation material are used for the fridge-freezer, causing no damage to the ozone layer and having a very small impact on the global warming, so it is the environmentally friendly product.

★Stylish appearance

Adopting the optimized man-machine engineering design, this French door refrigerator is easy to be opened and looks luxurious and elegant.

★More user-friendly designs

Such functions as wide working voltage range, automatic temperature control, power-off memory, power-on delay, automatic alarm, fast freezing, and fridge power-off, etc. are available.

Explosive views and parts list

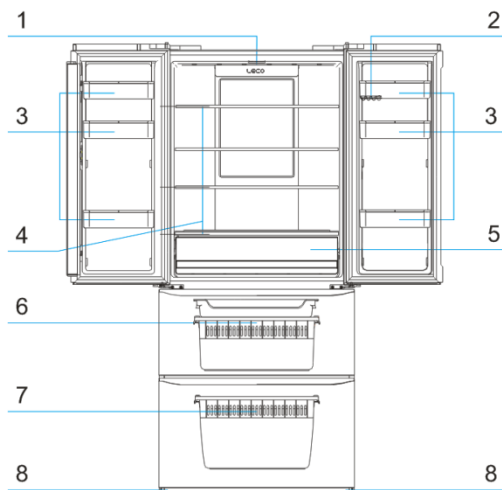

No	Description
1	Light
2	Egg Tray
3	Bottle Rack
4	Refrigerator Glass Shelf
5	Salad Crisper
6	Upper Freezer Drawer
7	Bottom Freezer Drawer
8	Adjustable Foot

Due to technological innovation, the descriptions of the product in this manual may not be completely consistent with your refrigerator. Details are in accordance with the material item.

III. Preparations for use

Installation location

1. Ventilation condition

The position you select for the refrigerator installation should be well-ventilated and has less hot air. Do not locate the refrigerator near a heat source such as cooker, boiler, and avoid it from direct sunlight, thus guaranteeing the refrigeration effect while saving energy consumption. Do not locate the refrigerator in the damp place, so as to prevent the refrigerator from rusting and leaking electricity. The result of the total space of the room in which the refrigerator is installed being divided by the refrigerant charge amount of the refrigerator shall not be less than 8 g/ M³.

Note: The amount of refrigerant charged for the refrigerator can be found on the nameplate.

2. Heat dissipation space

When working, the refrigerator gives off heat to surroundings. Therefore, at least 300mm (11.8") of free space should be spared at the top side, more than 100mm (3.9") on both sides, and above 50mm (2") at the back side of the refrigerator.

Dimensions in mm:

W	D	H	A	B	C(°)	E	F
785(31")	717(28.2")	1815(71.5")	1274(50.2")	1063(41.9")	125±5	50(2")	100(3.9")

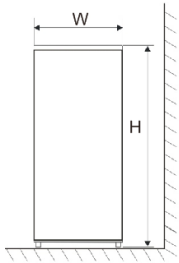

Fig. 1

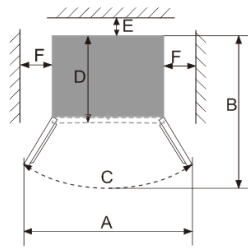

Fig. 2

Note: Figure 1, Figure 2 only illustrate the space demand of the product.

3. Level ground

Place the refrigerator on the solid and flat ground (floor) to keep it stable, or else, it will give rise to vibration and noise. When the refrigerator is placed on such flooring materials as carpet, straw mat, polyvinyl chloride, the solid backing plates should be applied underneath the refrigerator, so as to prevent color change due to heat dissipation.



Unobstructed ventilation shall be maintained around the appliance or in an embedded structure.

Preparations for use

1. Standing time

After the refrigerator is properly installed and well cleaned, do not switch it on immediately. Make sure to energize the refrigerator after more than 1 hour of standing, so as to ensure its normal operation.

2. Cleaning

Confirm the accessory parts inside the refrigerator and wipe the inside with a soft cloth.

3. Power-on

Insert the plug into the solid socket to start the compressor. After 1 hour, open the freezer door, if the temperature inside the freezer compartment drops obviously, it indicates the refrigeration system is working normally.

4. Storage of food

After the refrigerator runs for a period of time, the internal temperature of the refrigerator will be automatically controlled according to the user's temperature setting. After the refrigerator is fully cooled, put in foods, which usually need 2~3 hours to be fully cooled. In summer, when the temperature is high, it takes more than 4 hours for the foods to be fully cooled (Try to open the refrigerator door as less as possible before the internal temperature cools down).



If the refrigerator is installed in the moisture place, make sure to check whether the ground wire and leakage circuit breaker are normal. If vibration noises are produced due to the refrigerator contacting the wall or if the wall gets blackened by air convection around the compressor, move the refrigerator away from the wall. Setting up the refrigerator may cause jamming noise or image chaos to the mobile phone, fixed-line telephone, radio receiver, television set surrounding it, so try to keep the refrigerator as far away as possible in such case.

IV. Functions

The display panel is designed on the fridge door, illustrated as the right figure.

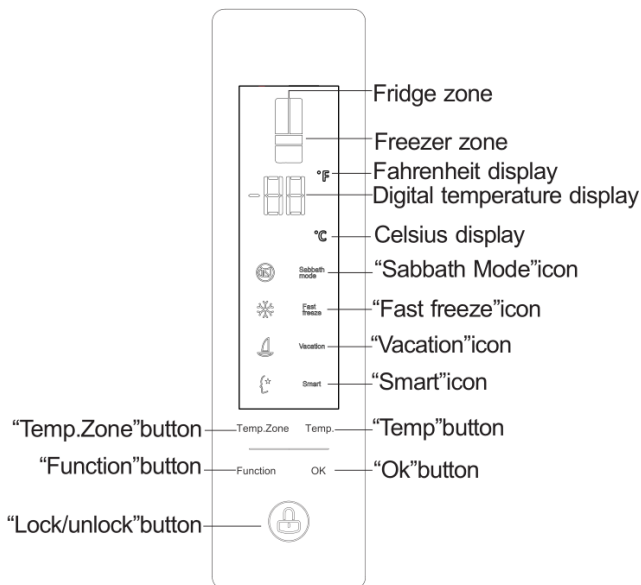

Function Setting

When the refrigerator system is connected to power supply for the first time, all icons on the display panel gets illuminated

for 2s, and the fridge temperature will be controlled at 38°F and the freezer temperature at -08°F.

When all the doors are close, the display gets extinguished automatically if no key operation within 3 minutes. When the display is off, it will light up if any door is opened or any key is pressed.

The following key operations are valid only when the keys are unlocked and gets illuminated on the display. (refer to 1.6 for unlocking the keys)

1.Functions

1.1Temp. setting

1) Temperature display

Every time when the refrigerator system is powered up, the set temperature of the refrigerator will be displayed in Fahrenheit by default. And you can switch between the Fahrenheit display and the Celsius display by holding down the Temp. Zone key for 3s.

Correspondence between the temperatures goes as follows

Fridge temp. display		Freezer temp. display	
Fahrenheit (°F)	Celsius (°C)	Fahrenheit (°F)	Celsius (°C)
34	1	3	-16
35	2	2	-17
36	2	1	-17
37	3	0	-18
38	3	-1	-18
39	4	-2	-19
40	4	-3	-19
41	5	-4	-20
42	5	-5	-20
43	6	-6	-21
		-7	-22
		-8	-22

2) Fridge temperature setting

Press the Temp. Zone key to select the fridge zone until the corresponding icon gets flickering, and then press the Temp. key to set the temperature as desired, finally, press the OK key or wait for 5s to validate the setting.

The fridge temperature setting cycles as following:

3°C→4°C→5°C→6°C→OF→1°C→2°C→3°C;

38°F→39°F→40°F→41°F→42°F→43°F→OF→34°F→35°F→36°F→37°F→38°F

OF indicates the fridge is switched off, and when the OF function takes effect, the fridge will stop cooling.

⚠ Be sure to take all foods out of the fridge compartment before setting this function.

3) Freezer temperature setting

Press the Temp. Zone key to select the freezer zone until the corresponding icon gets flickering, and then press the Temp. key to set the temperature as desire, finally press the OK key or wait for 5s to validate the setting.

The freezer temperature setting cycles as following:

-22°C→-21°C→-20°C→-19°C→-18°C→-17°C→-16°C→-22°C;

-8°F→ -7°F→ -6°F→ -5°F→ -4°F→ -3°F→ -2°F→ -1°F→ 0°F→ 1°F→ 2°F→ 3°F→ -8°F

1.2 LECO

1) When the refrigerator is powered on, the LECO net flavor function will run automatically on a regular basis, lasting for 20 minutes each time; the LECO system decomposes odors and microorganisms into CO2 and H2O. At the same time, the LECO system releases free radicals to actively eliminate bacteria, creating a cleaner cooling space.

2) Exiting the LECO function

◆ The LECO function gets exited automatically 20 minutes after it is enabled.

- ◆ When the Sabbath function is enabled, the LECO function gets exited automatically.

1.3 Fast Freezing

1) When the Fast Freezing function is enabled, the freezer temperature will be controlled at -26°F (-32°C) automatically, and after 26 hours of running, the Fast Freezing function gets exited. Cooling down the freezer temperature in a rapid manner is beneficial to the prevention of food nutrition against being lost and the preservation of freshness.



Under the Fast-Freezing mode, the freezer temperature is subjected to no adjustment.

2) Enabling the Fast-Freezing function

- ◆ Press the Function key to select Fast Freeze until the corresponding icon gets flickering, and then press the OK key within 5s for confirmation. If the OK key is not pressed within 5s, the setting will be invalidated.

3) Exiting the Fast-Freezing function

- ◆ After a cumulative running period of 26 hours, the Fast Freeze function will exit automatically.
- ◆ Under the Fast Freeze mode, press the Function key to select Fast Freeze until the corresponding icon gets flickering, and then press the OK key for confirmation, the Fast Freeze function will get exited.
- ◆ When the Smart function is enabled, the Fast-Freezing function will be disabled automatically.

1.4 Holiday

1) When the Holiday function is enabled, the freezer temperature will be controlled at 57°F (14°C). When you are out for a quite long time, you can set the Holiday function to keep the refrigerator running with low energy consumption, while ensuring the fresh food compartment is free from undesirable smell and the freezer compartment operates normally.



Be sure to take out all foods from the fresh food compartment before setting this function.



Under the Holiday mode, the fridge temperature is subject to no change.

2) Enabling the Holiday function

- ◆ Press the Function key to select Holiday until the corresponding icon gets flickering, and then press the OK key within 5s for confirmation. If the OK is not pressed within 5s, the setting will be invalidated.

3) Exiting the Holiday function

- ◆ Under the Holiday mode, press the Function key to select Holiday until the corresponding gets flickering, and then press the OK key for confirmation. The Holiday function will get exited.
- ◆ When the Smart function is enabled, the Holiday function will be disabled automatically.

1.5 Smart

1) When the Smart function is enabled, the temperature of the fresh food compartment is controlled at 38°F (3°C), and that of the freezer compartment at -02°F (-19°C), so that foods can be stored in the best condition while the refrigerator is running more efficiently and with better performance.



Under the Smart mode, the fresh food compartment temperature and the freezer compartment temperature are subject to no change.

2) Enabling the Smart function

- ◆ Press the Function key to select Smart until the corresponding icon gets flickering, and then press the OK key within 5s for confirmation. If the OK is not pressed within 5s, the setting will be invalidated.

3) Exiting the Smart function

- ◆ Under the Smart mode, press the Function key to select Smart until the corresponding gets flickering, and then press the OK key for confirmation. The Smart function will get exited.
- ◆ When the Holiday or Fast Freeze function is enabled, the Smart function will be disabled automatically.

1.6 Child Lock

1) When the Child Lock function is enabled, the temperature and function are subjected to no change to prevent maloperation.

2) In case of no key operation within 3 minutes, the Child Lock function will be enabled automatically.

3) Enabling/exiting the Child Lock function manually

- ◆ Press and hold down the Lock/Unlock for 3s, then the Child Lock function can be enabled/disabled.

1.7 Sabbath

1) When this function is enabled, the display screen is completely off, the buzzer stops working, the LED light does not light up in the case of door open, and LECO will not start. Setting this function on the day of Sabbath (the Jewish festival) can avoid unnecessary interferences, so as to cater for the customs of Judaism.

2) To enter Sabbath

- ◆ Press the Function key to select Sabbath until the corresponding icon gets flickering, and press the OK key within 5s to validate the setting; if the OK key is not pressed within 5s, the previous setting will be restored.

3) To exit Sabbath

- ◆ Hold down the Function key for 3s, the Sabbath function can be exited, with the refrigerator display restored to normal.

1.8 Door open alarm

When the Sabbath function is not enabled, if any door is open for more than 3 minutes, buzzer alarms will be continuously issued, which can be stopped by pressing any key, but will be restored after 3 minutes if the door keeps open. The alarms will not be lifted until the door is closed.

1.9 Power cut memory

In the case of power failure, the refrigerator will maintain the running state that is set before the power outage (excluding the Sabbath function).

1.10 Power-on delay

In order to protect the refrigerator compressor from being damaged in the case of short-time power failure (i.e., less than 5 minutes), the compressor will not be started immediately after it is powered on.

1.11 Over-temperature alarm (only after power outage)

When the refrigerator system is powered on, if the freezer sensor temperature is higher than -10°C , digits of the freezer zone get flickering on the display. The freezer temperature can be displayed when any key is pressed, and the normal display will be restored when any key is pressed again or after 10s.

1.12 Fault alarm

In case E0, E1, E2, EH, EC or EF is displayed on the operation panel, it indicates fault with the refrigerator. Please contact the aftersales person for visiting service in such case.

V. Instructions for food storage

Precautions for use

- The appliance might not operate consistently (there is possibility of defrosting or temperature becoming too warm in the frozen food compartment) when sited for an extended period of time below the cold limit of the temperature range for which the refrigerating appliance is designed
- The information of climate type of the appliance is provided on the rating plate.
- The internal temperature could be affected by such factors as the location of refrigerating appliance, ambient temperature, and frequency of door open, etc., and if appropriate, a warning that setting of any temperature control device might have to be varied to allow for these factors should be made.
- Effervescent drinks should not be stored in the freezer compartment or the low-temperature compartment, and some products such as water ices should not be consumed too cold.

Food storage location

Due to the cold air circulation in the refrigerator, the temperature of each area in the refrigerator is different, so different kinds of food should be placed in different areas.

The fresh food compartment is suitable for the storage of such foods as need not to be frozen, the cooked food, beer, eggs, some condiments that need cold preservation, milk, fruit juice, etc. The crisper box is suitable for the preservation of vegetables, fruits, etc.

The freezer compartment is suitable for the storage of ice cream, frozen food and the foods to be preserved for a long time.

Use of the fresh food compartment

Set the temperature of the fresh food storage compartment between $2^{\circ}\text{C} \sim 8^{\circ}\text{C}$, and store the foods that are intended for short-term storage, or to be eaten at any time in the fresh food compartment.

Fridge shelf: When removing the shelf, lift it up first, and then pull it out; and when installing the shelf, place it into position before putting it down. (For the two-section shelf, push the first section to the rear end, and then pull the second section out). Keep the shelf rear flange upward, to prevent foods from contact the liner wall. When taking out or putting in the shelf, hold it firmly, and handle with care to avoid damage.

Crisper box: Pull out the crisper box for access to food. After using or cleaning the cover plate of the crisper box, be sure to put it back onto the crisper, so that the internal temperature of the crisper box will not be affected.

Cautions for food storage

You'd better clean the foods and wipe them dry before storing them inside the refrigerator. Before foods are put in the refrigerator, it is advisable to seal them up, so as to prevent water evaporation to keep fresh fruits and vegetables on one hand, and prevent taint of odor on the other hand.

Do not put too many or too weight foods inside the refrigerator. Keep enough space between foods; if too close, the cold air flow will be blocked, thus affecting the refrigeration effect. Do not store excessive or overweight foods, to avoid the shelf from being crushed. When storing the foods, keep a distance away from the inner wall; and do not place the water-rich foods too close to the fridge rear wall, lest they get frozen on the inner wall.

Categorized storage of foods: Foods should be stored by category, with the foods you eat every day placed in front of the shelf, so that the door open duration can be shortened and food spoilage due to expiration can be avoid.

Energy-saving tips: Allow the hot food cool down to the room temperature before putting it in the refrigerator. Put the frozen food in the fresh food compartment to thaw, using the low temperature of the frozen food to cool the fresh food, thus saving energy.

Storage of fruits and vegetables

In the case of refrigerating appliances with chill compartment, a statement to the effect that some types of fresh vegetables and fruits are sensitive to cold and therefore are not suitable for storage in this kind of compartment should be made.

Use of the frozen food storage compartment

The freezer temperature is controlled below -18°C , and it is advisable to store the food for long-term preservation in the freezer compartment, but the storage duration indicated on the food packaging should be adhered to.

The freezer drawers are used to store food that needs to be frozen. Fish and meat of large block size should be cut into small pieces and packed into fresh-keeping bags before they are evenly distributed inside the freezer drawers.

Fast freezing

(1) Refer to the description about fast freezing function in the "Function" section.

(2) Compared with the normal freezing, fast freezing enables food to pass through the maximum ice crystal formation

zone at the fastest speed. Fast freezing can freeze the food water content into fine ice crystals, without damaging the cell membrane, so cell juice will not be lost when thawing, and the original freshness and nutrition of food can be maintained.

(3) The fast-freezing function is designed to preserve nutrition of the frozen food, with the food thoroughly frozen in the shortest time. Fast freezing consumes more energy than the normal freezing does.

- ★ Allow the hot foods to cool down to the room temperature before putting them in the freezer compartment.
- ★ Do not put a glass container with liquid or the canned liquid that is sealed in the freezer compartment, so as to avoid burst due to volume expansion after the liquid gets frozen up.
- ★ Divide the food into appropriately small portions
- ★ You'd better pack the food up before freezing it, and the packing bag used should be dry, in case the packing bags are frozen together. Foods should be packed or covered by such suitable materials as are firm, tasteless, impervious to air and water, non-toxic and pollution-free, to avoid cross-contamination and transfer of odor.

Tips for shopping the frozen foods

1. When you are buying frozen food, look at the Storage Guidelines on the packaging. You will be able to store each item of frozen food for the period shown against the star rating. This is usually the period stated as "Best to use them before*", found on the front of the packaging.
2. Check the temperature of the frozen food cabinet in the shop where you buy the frozen foods.
3. Make sure the frozen food package is in perfect condition.
4. Always buy frozen products last on your shopping trip or visit to the supermarket.
5. Try to keep frozen food together whilst shopping and on the journey home, as this will help to keep the food cooler.
6. Don't buy frozen food unless you can freeze it straight away. Special insulated bags can be bought from most supermarkets and hardware shops. These keep the frozen foods cold longer.
7. For some foods, thawing before cooking is unnecessary. Vegetables and pasta can be added directly to boiling water or steam cooked. Frozen sauces and soups can be put into a saucepan and heated gently until thawed.
8. Use quality food and handle it as little as possible. When foods are frozen in small quantities, it will take less than for them to freeze up and thaw.
9. Estimate the amount of foods to be frozen up. When freezing large amounts of fresh food, adjust the temperature control knob to the low mode, with the freezer temperature lowered. So, foods can be frozen up in fast manner, with the food freshness well kept.

VI. Tips for special needs

Moving the refrigerator/freezer

•Location

Do not place your refrigerator/freezer near a heat source, e.g. cooker, boiler or radiator. Avoid it from direct sunlight in out-buildings or sun lounges.

•Leveling

Make sure to level your refrigerator/freezer using the front leveling feet. If not level, the refrigerator/freezer door gasket sealing performance will be affected, or even it may lead to the operating failure of your refrigerator/freezer.

After locating the refrigerator/freezer in position, wait for 4 hours before using it, so as to allow the refrigerant to settle.

•Installation

Do not cover or block the vents or grilles of your appliance.

When you are out for a long time

- If the appliance will not be used for several months, turn it off first, and then unplug the plug from the wall outlet.
- Take out all foods.
- Clean and dry the interior thoroughly. To prevent odor and mold growth, leave the door ajar: block it open or have the door removed if necessary.
- Keep the cleaned appliance in a dry, ventilated place and away from the heat source, place the appliance smoothly, and do not place heavy objects on top of it.
- The unit should not be accessible to child's play.

VII. Maintenance and cleaning

 **Before cleaning, unplug the power plug first; Do not plug in or plug out the plug with wet hand, because there is a risk of electric shock and injury. Do not spill water directly on the refrigerator, to avoid rust, electricity leakage and accidents. Do not stretch your hands into the bottom of the refrigerator, since you might be scratched by sharp metal corners.**

Internal cleaning and external cleaning

The food residuals in the refrigerator are liable to produce bad odor, so the refrigerator must be cleaned regularly. The fresh food compartment is usually cleaned once a month.

Remove all shelves, crisper box, bottle racks, cover board, and drawers etc., and clean them with a soft towel or sponge dipped in warm water or neutral detergent.

Clear off the dusts accumulated on the rear panel and side plates of the refrigerator often.

After using detergent, be sure to rinse it with clean water, and then wipe it dry.

 **Do not use bristle brush, steel wire brush, detergent, soap powder, alkaline detergent, benzene, gasoline, acid, hot water and other corrosive or soluble items to cleanse the cabinet surface, door gasket, plastic decorative parts, etc., so as to avoid damage.**

Carefully wipe dry the door gasket, clean the groove using a wooden chopstick wrapped with cotton string. After the cleaning, fix the four corners of the door gasket first, and then embed it segment by segment into the door groove.
 Interruption of power supply or failure of the refrigerating system

- Take care of the frozen foods in the event of an extended non-running of the refrigerating appliance (such as interruption of power supply or failure of the refrigerating system).
- Try to open the refrigerator door as less as possible, in this way can food safely and freshly kept for hours even in hot summer.
- If you get the power outage notice in advance:
 - 1) Adjust the thermostat knob to the high mode an hour in advance, so that foods get fully frozen (Do not store new food during this time!). Restore the temperature mode to the original setting when power supply becomes normal in a timely manner.
 - 2) You can also make ice with a watertight container, and put it in the upper part of the freezer, so as to extend the time for fresh food to be stored.

! **Note: Once the refrigerator is used, you'd better use it continuously; and under normal circumstance, do not stop its use, so as not to affect the service life.**

Defrosting

This appliance is designed with automatic defrosting function, thus no need to defrost it manually.

Changing the lamp

The LED lamp is used by the refrigerator for lighting, which features low energy consumption and long service life. In case of any abnormality, please contact the after-sales personnel for visiting service. The lamps can only be replaced by the manufacturer, together with a part of the appliance.

Safety-check after maintenance

- Is the power cord broken or damaged?
- Is the power plug firmly inserted into the socket?
- Is the power plug abnormally overheat?

! **Note: Electric shock and fire accident may be caused in case the power cord and plugs damaged or stained by dust. If any abnormality, please unplug the power plug and get in contact with the vendor.**

How to disassemble the parts.

Fridge door bottle rack:

Hold the bottle rack with both hands, and then push it up.

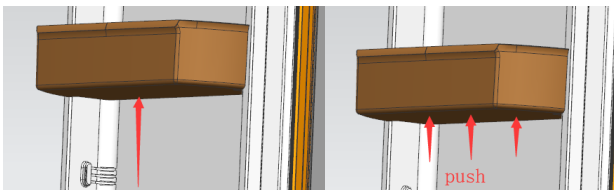

Fridge shelf:

Hold one end of the shelf, and lift it up while pulling it outwards.

VIII. Simple fault analysis and elimination

With regard to the following small faults, not every failure needs to be fixed by the technical service personnel; you can try to solve the problem.

Case	Inspection	Solutions
Completely non-refrigeration	<ul style="list-style-type: none"> •Is power plug off? •Are breakers and fuses broken? •No electricity or line trip? 	<ul style="list-style-type: none"> •Re-plug •Opening the door and checking whether the lamp is lit.
Abnormal noise	<ul style="list-style-type: none"> •Is refrigerator stable? •Does refrigerator contact the wall? 	<ul style="list-style-type: none"> •Adjusting refrigerator's leveling feet. •Off the wall.
Poor refrigerating efficiency	<ul style="list-style-type: none"> •Do you put hot food or too much food? •Do you open the door frequently? •Do you clip food bag to the door gasket? •Direct sunlight or near a furnace or stove? •Is it well-ventilated? •Temperature setting in too high? 	<ul style="list-style-type: none"> •Putting food into refrigerator when hot food becomes cool. •Checking and closing the door. •Removing the refrigerator from the heat source. •Emptying the distance to maintain good ventilation.. •Setting to the appropriate temperature.
Peculiar smell in refrigerator	<ul style="list-style-type: none"> •Any spoiled food? •Do you need to clean refrigerator? •Have you packed food of strong 	<ul style="list-style-type: none"> •Throwing away spoiled food. •Cleaning refrigerator. •Packing food of strong flavors.

	flavors?	
•No key response	• Check whether the Child Lock function is enabled on the display panel.	•Press & hold the "OK" key for 3 seconds to unlock the key, and then conduct the key operation. (For details, refer to the Child Key function.)
•Temperature setting impossible	• Check whether the Smart, Fast Freeze or Holiday function is enabled on the display panel.	•Exit the special function mode, and then set up the temperature (for details refer to the Functions section)
•Freezer temperature displayed on the panel, with the temperature digits flashing	•Is power cut before?	• Press any key to lift the alarm (refer to the Overtemperature alarm function), and then check the foods inside the fridge and freezer compartments get spoiled.
• The left fridge door unable to be closed tightly.	• Check whether the flip beam is restored to its original position.	•Turn the door flip beam by hand to restore it to the correct position, and then close the door. 

(⚠) Note: If the above descriptions are inapplicable to troubleshooting, do not disassemble and repair it yourself. Repairs carried out by inexperienced persons may cause injury or serious malfunctioning. Contact the local store where your purchase was made. This product should be serviced by an authorized engineer and only genuine spare parts should be used.

When the appliance is not in use for long periods, disconnect from the electricity supply, empty all foods and clean the appliance, leaving the door ajar to prevent unpleasant smells.

IX. Certifications

Electrical information

This electrical appliance must be grounded

This product is equipped with a plug, which is suitable for all houses equipped with sockets meeting the current specifications

If the fitted plug is not suitable for your socket outlets, it should be cut off and carefully disposed of. To avoid a possible shock hazard, do not insert the discarded plug into a socket.

This product complies the EEC directives.

X. Safe recovery instructions

Disposal

Old appliances still have some surplus value. An environmentally friendly approach will ensure that valuable raw materials are recycled.

The refrigerants used in your equipment and insulation materials require special handling procedures. Make sure there is no pipe damage on the back of the equipment before handling.

Up-to-date information on the options for disposing of old equipment and packaging from old equipment can be obtained from the local municipal office.