

CHiQ

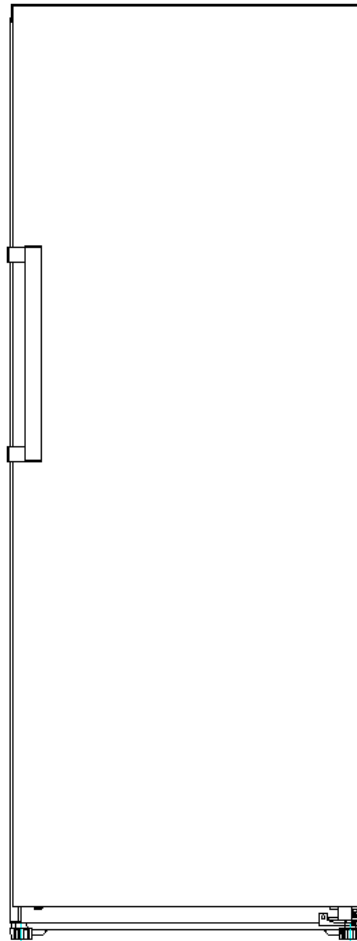

INSTRUCTION MANUAL

Model No.: CQFU13Y1GD1W

Contents

I. SAFETY (general safety warnings)	Erro! Indicador não definido.
II. Product Features	5
III. Preparations for use	5
IV. Functions	6
V. Instructions for food storage	6
VI. Tips for special needs	7
VII. Maintenance and cleaning	7
VIII. Simple fault analysis and elimination (varying with different products)	8
IX. Certifications (to be provided by Certification Engineer)	9
X. Safe recovery instructions	9

I. IMPORTANT SAFETY INSTRUCTIONS

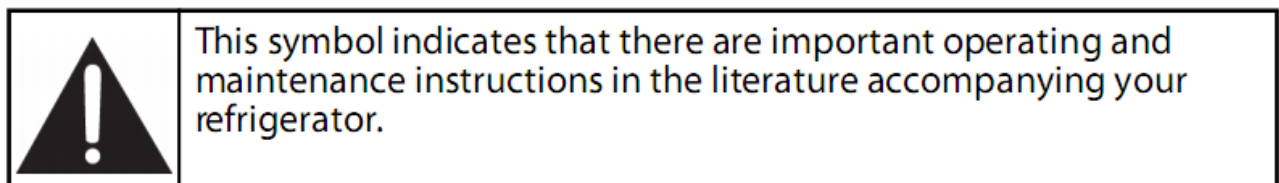
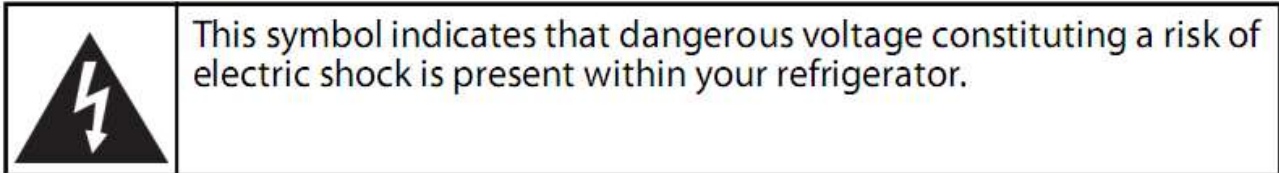

WARNING 1 Read these instructions.

1. Read these instructions.
2. Keep these instructions.
3. Heed all warnings.
4. Follow all instructions.
5. Do not use your refrigerator near water.
6. Clean only with a damp cloth.
7. Do not block any ventilation openings. Install in accordance with the manufacturer's instructions.
8. Do not install near any heat sources, such as radiators, heat registers, stoves, or other apparatus (including amplifiers) that produce heat.
9. Do not defeat the safety purpose of the polarized or grounding-type plug. A polarized plug has two blades with one wider than the other. A grounding type plug has two blades and a third grounding prong. The wide blade or the third prong is provided for your safety. If the provided plug does not fit into your outlet, consult an electrician for replacement of the obsolete outlet.
10. Protect the power cord from being walked on or pinched, particularly at plugs, convenience receptacles, and the point where it exits from your refrigerator.
11. Do not attempt to modify or extend the power cord of your refrigerator.
12. Unplug your refrigerator during lightning storms or when it will not be used for long periods of time.
13. Make sure that the available AC power matches the voltage requirements of your refrigerator.
14. Do not handle the plug with wet hands. This could result in an electric shock.
15. Unplug the power cord by holding the plug, never by pulling the cord.
16. Turn off your refrigerator before unplugging it.
17. Refer all servicing to qualified service personnel. Servicing is required when your refrigerator has been damaged in any way, such as the power-supply cord or plug is damaged, liquid has been spilled or objects have fallen into your refrigerator, your refrigerator has been exposed to rain or moisture, does not operate normally, or has been dropped.
18. To reduce the risk of fire or electric shock, do not expose your refrigerator to rain, moisture, dripping, or splashing, and no objects filled with liquids should be placed on top of it.
19. Do not use extension cords or ungrounded (two prong) adapters. If the power cord is too short, have a qualified electrician install an outlet near your refrigerator. Use of an extension cord can negatively affect your refrigerator's performance.
20. Your refrigerator is not intended for use by persons (including children) with reduced physical, sensory, or mental capabilities, or lack of experience and knowledge, unless they have been given supervision or instruction concerning use of your refrigerator by a person responsible for their safety.
21. Children should be supervised to ensure that they do not play with your refrigerator.
22. If the power cord is damaged, it must be replaced by the manufacturer, its service agent, or similarly qualified person, in order to avoid a hazard.



WARNING

Electric Shock Hazard

Failure to follow these instructions can result in electric shock, fire, or death.

1. WARNING—Keep ventilation openings, in both your refrigerator and the built-in structure, clear of obstruction.

2. WARNING—Do not touch the interior of your refrigerator with wet hands. This could result in frostbite.

3. WARNING—Do not use mechanical devices or other means to accelerate the defrosting process, other than those recommended by the manufacturer.

4. WARNING—Do not damage the refrigerant circuit.

5. WARNING—Do not damage the refrigerant tubing when handling, moving, or using your refrigerator.

6. WARNING—DANGER—Never allow children to play with, operate, or crawl inside your refrigerator.

Risk of child entrapment. Before you throw away your old refrigerator:

- Take off the door.
- Leave the shelves in place so that children may not easily climb inside.

7. WARNING—Do not use electrical appliances inside the food storage compartments of the appliance unless they are of the type recommended by the manufacturer.

8. Unplug your refrigerator before carrying out user maintenance on it.

9. If a component part is damaged, it must be replaced by the manufacturer, its service agent, or similar qualified persons in order to avoid a hazard.

10. Follow local regulations regarding disposal of your refrigerator due to flammable refrigerant and gas. All refrigeration products contain refrigerants, which under the guidelines of federal law must be removed before disposal. It is the consumer's responsibility to comply with federal and local regulations when disposing of this product.

11. Do not store explosive substances such as aerosol cans with a flammable propellant in this appliance.

12. This appliance is intended to be used in household and similar applications such as

- staff kitchen areas in shops, offices and other working environments.
- farm houses and by clients in hotels, motels and other residential type environments.
- bed and breakfast type environments.
- catering and similar non-retail applications.

Grounding requirement

Your refrigerator must be grounded. Your refrigerator is equipped with a cord having a grounding wire with a grounding plug. The plug must be inserted into an outlet that is correctly installed and grounded.

Incorrect use of the grounding plug can result in a risk of electric shock. Consult a qualified electrician or service person if the grounding instructions are not completely understood, or if doubt exists as to whether your refrigerator is correctly grounded.

Electrical Connection

⚡WARNING⚡

This appliance should be properly grounded for your safety. The power cord of this appliance is equipped with a three-prong plug which mates with the standard three prong wall outlets to minimize the possibility of electrical shock.

Do not, under any circumstances, cut or remove the third ground prong from the power cord supplied.

This refrigerator appliance requires a standard 115VAC /60Hz electrical outlet with three-prong ground.

This refrigerator appliance is not designed to be used with an inverter.

The cord should be secured behind the appliance and not left exposed or dangling to prevent accidental injury.

Never unplug the refrigerator by pulling the power cord. Always grip the plug firmly and pull straight out from the receptacle.

Do not use an extension cord with this appliance. If the power cord is too short, have a qualified electrician or service technician install an outlet near the appliance. Use of an extension cord can negatively affect the performance of the unit. Improper use of the grounded plug can result in the risk of electrical shock. If the power cord is damaged, have it replaced by an authorized service center.

Locks

If your Refrigerator is fitted with a lock, keep the key out of reach and not in the vicinity of the appliance to prevent children being entrapped. When disposing of an old Refrigerator, break off any old locks or latches as a safeguard.

Freon-free

The freon-free refrigerant (R600a) and the foaming insulation material (cyclopentane) that is environmentally friendly are used for the refrigerator, causing no damage to the ozone layer and having a very small impact on the global warming. R600a is flammable, and sealed in a refrigeration system, without leakage during normal use. But, in case of refrigerant leakage due to the refrigerant circuit being damaged, be sure to keep the appliance away from open flames and open the windows for ventilation as quickly as possible.

II. Product Features

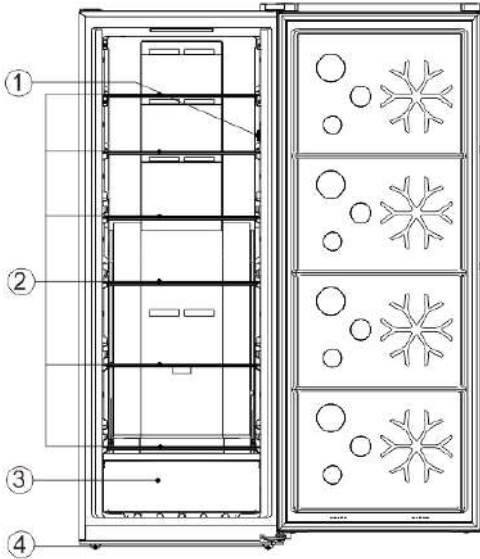

No	Description
1	Temperature control knob
2	Glass shelves
3	Freezer drawer
4	Adjustable Feet

Due to technological innovations, the product descriptions in this manual may not be completely consistent with your refrigerator. Detailed information is in accordance with the final product.

III. Preparations for use

Installation location:

1. Ventilation condition

The position you select for the refrigerator installation should be well-ventilated and has less hot air. Do not locate the refrigerator near a heat source such as cooker, and avoid it from direct sunlight, thus guaranteeing the refrigeration effect while saving energy consumption. Do not locate the refrigerator in the damp place, so as to prevent the refrigerator from rusting and leaking electricity. The result of the total space of the room in which the refrigerator is installed being divided by the refrigerant charge amount of the refrigerator shall not be less than 8 g/ M^3 .

Note: The amount of refrigerant charged for the refrigerator can be found on the nameplate.

2. Heat dissipation space

When working, the refrigerator gives off heat to surroundings. Therefore, at least 300mm of free space should be spared at the top side, more than 100mm on both sides, and above 50mm at the back side of the refrigerator.

Dimensions in mm:

W	D	H	A	B	C(°)	E	F
710	770	1855	1197	1357	130	50	100

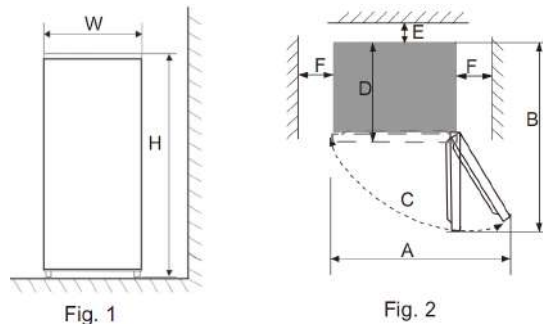

Note: Figure 1, Figure 2 only illustrate the space demand of the product.

3. Level ground

Place the refrigerator on the solid and flat ground (floor) to keep it stable, or else, it will give rise to vibration and noise. When the refrigerator is placed on such flooring materials as carpet, straw mat, polyvinyl chloride, the solid backing plates should be applied underneath the refrigerator, so as to prevent color change due to heat dissipation.



Unobstructed ventilation shall be maintained around the appliance or in an embedded structure.

Preparations for use

1. Standing time

After the refrigerator is properly installed and well cleaned, do not switch it on immediately. Make sure to energize the

refrigerator after more than 1 hour's standing, so as to ensure its normal operation.

2. Cleaning

Confirm the accessory parts inside the refrigerator and wipe the inside with a soft cloth.

3. Power-on

Insert the plug into the solid socket to start the compressor. After 1 hour, open the refrigerator door, if the temperature inside the refrigerator compartment drops obviously, it indicates the refrigeration system is working normally.

4. Storage of food

After the refrigerator runs for a period of time, the internal temperature of the refrigerator will be automatically controlled according to the user's temperature setting. After the refrigerator is fully cooled, put in foods, which usually need 2~3 hours to be fully cooled. In summer, when the temperature is high, it takes more than 4 hours for the foods to be fully cooled (Try to open the refrigerator door as less as possible before the internal temperature cools down).

! If the refrigerator is installed in the moisture place, make sure to check whether the ground wire and leakage circuit breaker are normal. If vibration noises are produced due to the refrigerator contacting the wall or if the wall gets blackened by air convection around the compressor, move the refrigerator away from the wall. Setting up the refrigerator may cause jamming noise or image chaos to the mobile phone, fixed-line telephone, radio receiver, television surrounding it, so try to keep the refrigerator as far away as possible in such case.

IV. Functions

START

The internal temperature of the appliance is controlled by a knob installed in the refrigerated compartment.

The knob dial is divided into two areas (i.e., right and left). When the knob is adjusted within the left area, the appliance is set at the fridge mode; and when the knob is adjusted within the right area, the appliance is at the freezer mode. Five modes are available in each area for the temperature control.

The set temperature decreases successively as the control knob is switched in the clockwise direction.

! Note: A buffer is designed between the fridge area and the freezer area, and do not make the knob switch stay in the buffer area when setting the temperature.

! Note: When you find LED lights flashing all the time, please contact the after-sales staff for site service as soon as possible.

Under the normal operating condition, it is recommended to set the fridge or freezer temperature at the Middle mode.

Adjusting the refrigeration temperature:

1. At the fridge mode (left area): When the temperature control knob is switched from "cold" to "coldest", the appliance temperature gradually drops.
2. At the freezer mode (right area): When the temperature control knob is switched from the "cold" to "the coldest", the appliance temperature decreases gradually.

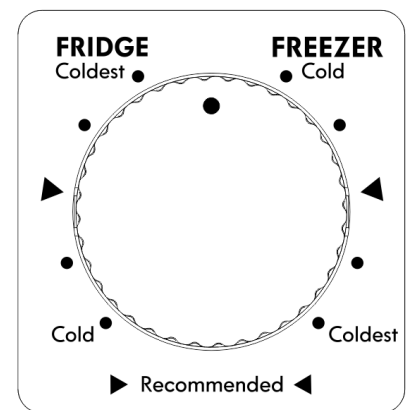

V. Instructions for food storage

Precautions for use

- The appliance might not operate consistently (there is possibility of defrosting or temperature becoming too warm in the frozen food compartment) when sited for an extended period of time below the cold limit of the temperature range for which the refrigerating appliance is designed
- The information of climate type of the appliance is provided on the rating plate.
- The internal temperature could be affected by such factors as the location of refrigerating appliance, ambient temperature, and frequency of door open, etc., and if appropriate, a warning that setting of any temperature control device might have to be varied to allow for these factors should be made.
- Effervescent drinks should not be stored in the freezer compartment or the low-temperature compartment, and some products such as water ices should not be consumed too cold.

Food storage

In the fridge mode: It is suitable for the storage of such foods as need not to be frozen, the cooked food, beer, eggs, some condiments that need cold preservation, milk, fruit juice, etc.

In the freezer mode, it is suitable for the storage of ice cream, frozen food and the foods to be preserved for a long time.

Fridge shelf: When removing the shelf, lift it up first, and then pull it out; and when installing the shelf, place it into position before putting it down.

Crisper box: Pull out the crisper box for access to food.

Cautions for food storage (in the fridge mode)

You'd better clean the foods and wipe them dry before storing them inside the refrigerator. Before foods are put in the refrigerator, it is advisable to seal them up, so as to prevent water evaporation to keep fresh fruits and vegetables on one hand, and prevent taint of odor on the other hand.

Do not put too many or too weight foods inside the refrigerator. Keep enough space between foods; if too close, the cold air flow will be blocked, thus affecting the refrigeration effect. Do not store excessive or overweight foods, to avoid the shelf from being crushed. When storing the foods, keep a distance away from the inner wall; and do not place the water-rich foods too close to the fridge rear wall, lest they get frozen on the inner wall.

Categorized storage of foods: Foods should be stored by category, with the foods you eat every day placed in front of the

shelf, so that the door open duration can be shortened and food spoilage due to expiration can be avoided.

Energy-saving tips: Allow the hot food cool down to the room temperature before putting it in the refrigerator. Put the frozen food in the fresh food compartment to thaw, using the low temperature of the frozen food to cool the fresh food, thus saving energy.

Storage of fruits and vegetables

In the case of refrigerating appliances with chill compartment, a statement to the effect that some types of fresh vegetables and fruits are sensitive to cold and therefore are not suitable for storage in this kind of compartment should be made.

In the freezer mode

The freezer temperature is controlled below $-18\text{ }^{\circ}\text{C}$, and it is advisable to store the food for long-term preservation in the freezer compartment, but the storage duration indicated on the food packaging should be adhered to.

The freezer drawers are used to store food that needs to be frozen. Fish and meat of large block size should be cut into small pieces and packed into fresh-keeping bags before they are evenly distributed inside the freezer drawers.

Fast freezing

- (1) Refer to the description about fast freezing function in the "Function" section.
- (2) Compared with the normal freezing, fast freezing enables food to pass through the maximum ice crystal formation zone at the fastest speed. Fast freezing can freeze the food water content into fine ice crystals, without damaging the cell membrane, so cell juice will not be lost when thawing, and the original freshness and nutrition of food can be maintained.
- (3) The fast-freezing function is designed to preserve nutrition of the frozen food, with the food thoroughly frozen in the shortest time. Fast freezing consumes more energy than the normal freezing does.

★ Allow the hot foods to cool down to the room temperature before putting them in the freezer compartment.

★ Do not put a glass container with liquid or the canned liquid that is sealed in the freezer compartment, so as to avoid burst due to volume expansion after the liquid gets frozen up.

★ Divide the food into appropriately small portions

★ You'd better pack the food up before freezing it, and the packing bag used should be dry, in case the packing bags are frozen together. Foods should be packed or covered by such suitable materials as are firm, tasteless, impervious to air and water, non-toxic and pollution-free, to avoid cross-contamination and transfer of odor.

Tips for shopping the frozen foods

1. When you are buying frozen food, look at the Storage Guidelines on the packaging. You will be able to store each item of frozen food for the period shown against the star rating. This is usually the period stated as "Best to use them before*", found on the front of the packaging.

2. Check the temperature of the frozen food cabinet in the shop where you buy the frozen foods.

3. Make sure the frozen food package is in perfect condition.

4. Always buy frozen products last on your shopping trip or visit to the supermarket.

5. Try to keep frozen food together whilst shopping and on the journey home, as this will help to keep the food cooler.

6. Don't buy frozen food unless you can freeze it straight away. Special insulated bags can be bought from most supermarkets and hardware shops. These keep the frozen foods cold longer.

7. For some foods, thawing before cooking is unnecessary. Vegetables and pasta can be added directly to boiling water or steam cooked. Frozen sauces and soups can be put into a saucepan and heated gently until thawed.

8. Use quality food and handle it as little as possible. When foods are frozen in small quantities, it will take less than for them to freeze up and thaw.

9. Estimate the amount of foods to be frozen up. When freezing large amounts of fresh food, adjust the temperature control knob to the low mode, with the freezer temperature lowered. So, foods can be frozen up in fast manner, with the food freshness well kept.

VI. Tips for special needs

Moving the refrigerator/freezer

•Location

Do not place your refrigerator/freezer near a heat source, e.g. cooker, boiler or radiator. Avoid it from direct sunlight in out-buildings or sun lounges.

•Leveling

Make sure to level your refrigerator/freezer using the front leveling feet. If not level, the refrigerator/freezer door gasket sealing performance will be affected, or even it may lead to the operating failure of your refrigerator/freezer.

After locating the refrigerator/freezer in position, wait for 4 hours before using it, so as to allow the refrigerant to settle.

•Installation

Do not cover or block the vents or grilles of your appliance.

When you are out for a long time

• If the appliance will not be used for several months, turn it off first, and then unplug the plug from the wall outlet.

• Take out all foods.

• Clean and dry the interior thoroughly. To prevent odor and mold growth, leave the door ajar: block it open or have the door removed if necessary.

• Keep the cleaned appliance in a dry, ventilated place and away from the heat source, place the appliance smoothly, and do not place heavy objects on top of it.

•The unit should not be accessible to child's play.

VII. Maintenance and cleaning



Before cleaning, unplug the power plug first; Do not plug in or plug out the plug with wet hand, because there is a risk

of electric shock and injury. Do not spill water directly on the refrigerator, to avoid rust, electricity leakage and accidents. Do not stretch your hands into the bottom of the refrigerator, since you might be scratched by sharp metal corners.

Internal cleaning and external cleaning

The food residuals in the refrigerator are liable to produce bad odor, so the refrigerator must be cleaned regularly. The fresh food compartment is usually cleaned once a month.

Remove all shelves, crisper box, bottle racks, cover board, and drawers etc., and clean them with a soft towel or sponge dipped in warm water or neutral detergent.

Clear off the dusts accumulated on the rear panel and side plates of the refrigerator often.

After using detergent, be sure to rinse it with clean water, and then wipe it dry.

 Do not use bristle brush, steel wire brush, detergent, soap powder, alkaline detergent, benzene, gasoline, acid, hot water and other corrosive or soluble items to cleanse the cabinet surface, door gasket, plastic decorative parts, etc., so as to avoid damage.

Carefully wipe dry the door gasket, clean the groove using a wooden chopstick wrapped with cotton string. After the cleaning, fix the four corners of the door gasket first, and then embed it segment by segment into the door groove.

Interruption of power supply or failure of the refrigerating system

- Take care of the frozen foods in the event of an extended non-running of the refrigerating appliance (such as interruption of power supply or failure of the refrigerating system).
- Try to open the refrigerator door as less as possible, in this way can food safely and freshly kept for hours even in hot summer.
- If you get the power outage notice in advance:
 - 1) Adjust the thermostat knob to the high mode an hour in advance, so that foods get fully frozen (Do not store new food during this time!). Restore the temperature mode to the original setting when power supply becomes normal in a timely manner.
 - 2) You can also make ice with a watertight container, and put it in the upper part of the freezer, so as to extend the time for fresh food to be stored.

 Note: Once the refrigerator is used, you'd better use it continuously; and under normal circumstance, do not stop its use, so as not to affect the service life.

Defrosting

This appliance is designed with automatic defrosting function, thus no need to defrost it manually.

Changing the lamp

The LED lamp is used by the refrigerator for lighting, which features low energy consumption and long service life. In case of any abnormality, please contact the after-sales personnel for visiting service.

Safety-check after maintenance

Is the power cord broken or damaged?

Is the power plug firmly inserted into the socket?

Is the power plug abnormally overheat?

 Note: Electric shock and fire accident may be caused in case the power cord and plug is damaged or stained by dust. If any abnormality, please unplug the power plug and get in contact with the vendor.

How to disassemble the parts

Refrigerator shelf:

Hold the bottle rack with both hands, and then push it up.

Flip cover:

Keep the flip cover in the vertical direction, align its right side with the revolving shaft opening, and then pull out with force to disassemble the flip cover.

 Note: It is forbidden to close the door when the flip cover is opened, otherwise the refrigerator door may be damaged.

VIII. Simple fault analysis and elimination

With regard to the following small faults, not every failure needs to be fixed by the technical service personnel; you can try to solve the problem.

Case	Inspection	Solutions
• Completely non-refrigeration	<ul style="list-style-type: none"> • Is power plug off? • Are breakers and fuses broken? • No electricity or line trip? 	<ul style="list-style-type: none"> • Re-plug • Opening the door and checking whether the lamp is lit.
• Abnormal noise	<ul style="list-style-type: none"> • Is refrigerator stable? • Does refrigerator contact the wall? 	<ul style="list-style-type: none"> • Adjusting refrigerator's leveling feet. • Off the wall.
• Poor refrigerating efficiency	<ul style="list-style-type: none"> • Do you put hot food or too much food? • Do you open the door frequently? • Do you clip food bag to the door gasket? • Direct sunlight or near a furnace or stove? • Is it well-ventilated? • Temperature setting in too high? 	<ul style="list-style-type: none"> • Putting food into refrigerator when hot food becomes cool. • Checking and closing the door. • Removing the refrigerator from the heat source. • Emptying the distance to maintain good ventilation. • Setting to the appropriate temperature.

•Peculiar smell in refrigerator	•Any spoiled food? •Do you need to clean refrigerator? •Have you packed food of strong flavors?	•Throwing away spoiled food. •Cleaning refrigerator. •Packing food of strong flavors.
•The refrigerator lamp being OFF.	•Does the refrigerator door stay open?	•Close the door and open it again, so as to observe whether the refrigerator light up normally.

(⚠️ Note: If the above descriptions are inapplicable to troubleshooting, do not disassemble and repair it yourself. Repairs carried out by inexperienced persons may cause injury or serious malfunctioning. Contact the local store where your purchase was made. This product should be serviced by an authorized engineer and only genuine spare parts should be used.

When the appliance is not in use for long periods, disconnect from the electricity supply, empty all foods and clean the appliance, leaving the door ajar to prevent unpleasant smells.)

IX. Certifications

Electrical information

This electrical appliance must be grounded

This product is equipped with a plug, which is suitable for all houses equipped with sockets meeting the current specifications

If the fitted plug is not suitable for your socket outlets, it should be cut off and carefully disposed of. To avoid a possible shock hazard, do not insert the discarded plug into a socket.

This product complies with the EEC directives:

X. Safe recovery instructions

Disposal

Old appliances still have some surplus value. An environmentally friendly approach will ensure that valuable raw materials are recycled.

The refrigerants used in your equipment and insulation materials require special handling procedures. Make sure there is no pipe damage on the back of the equipment before handling.

Up-to-date information on the options for disposing of old equipment and packaging from old equipment can be obtained from the local municipal office.

Reversing the Door Swing

1. Screw off the screws of the upper hinge cover, and remove the upper hinge cover.

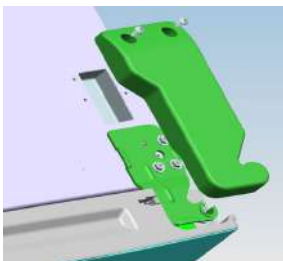

2. Screw off the three bolts fixing the upper hinge, remove the upper hinge, and pry off the door shaft sleeve, magnet and the proximity switch on the upper hinge cover.

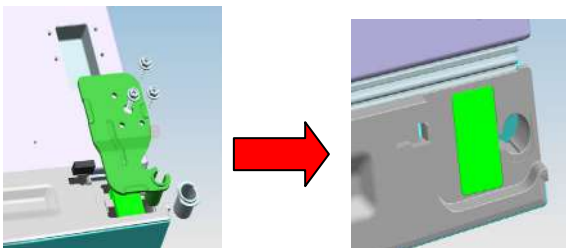

3. Screw off the three bolts fixing the top box cover on the left side, remove the box cover, take the wire harness out of the hole, and transfer the door shaft sleeve from right

side to the left side for installation.

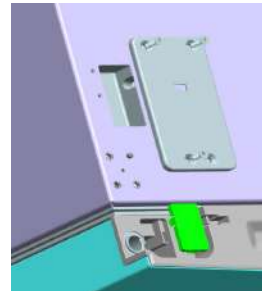

4. Lift up the refrigerator door by 50mm to remove it.

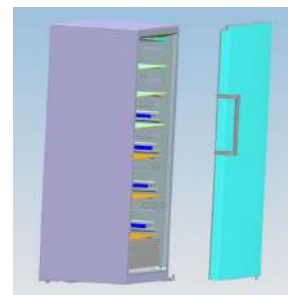

5. Remove the front leveling foot, screw off the 4 screws fixing the hinge, and remove the lower hinge.

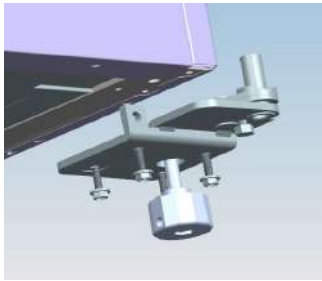

6. Take out the lower left hinge from the accessory bag, and install it on the refrigerator.

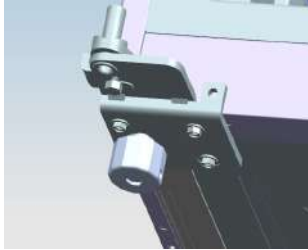

7. Remove the door stopper and door closer, take out the door closer from the accessory bag, and install it on the left side of the door.

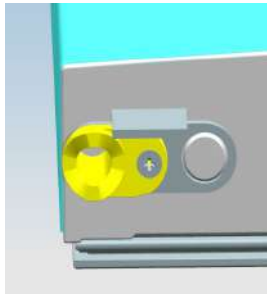

8. Install the door on the refrigerator.

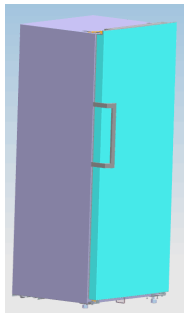

9. Take out the bolts of the upper left hinge from the accessory bag, fix them on the cabinet, and connect the wiring harness.



10. Take out the top left hinge cover, connect it with the wiring harness, and install them on the cabinet.

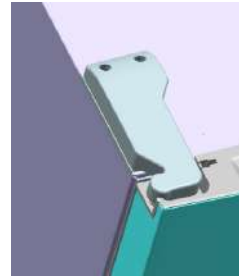

11. Install the magnet on the left side of the door.



12. Remove the help handle cover, screw off the handle screws, and dismantle the handle, as illustrated by the figure:

13. Install the help handle on the other side of the door after rotating it by 180° vertically, as shown in the figure:

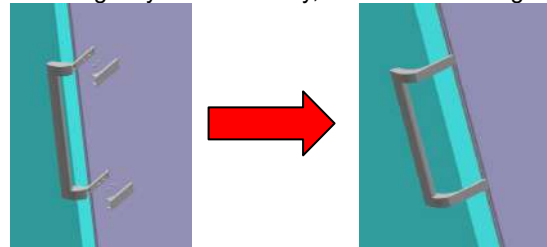

14. In this way, reversing the door swing can be finished, as shown in the figure:

